

# XW-G1

## USER'S GUIDE

Please keep all information for future reference.

### **Safety Precautions**

Before trying to use the instrument, be sure to read the separate "Safety Precautions".

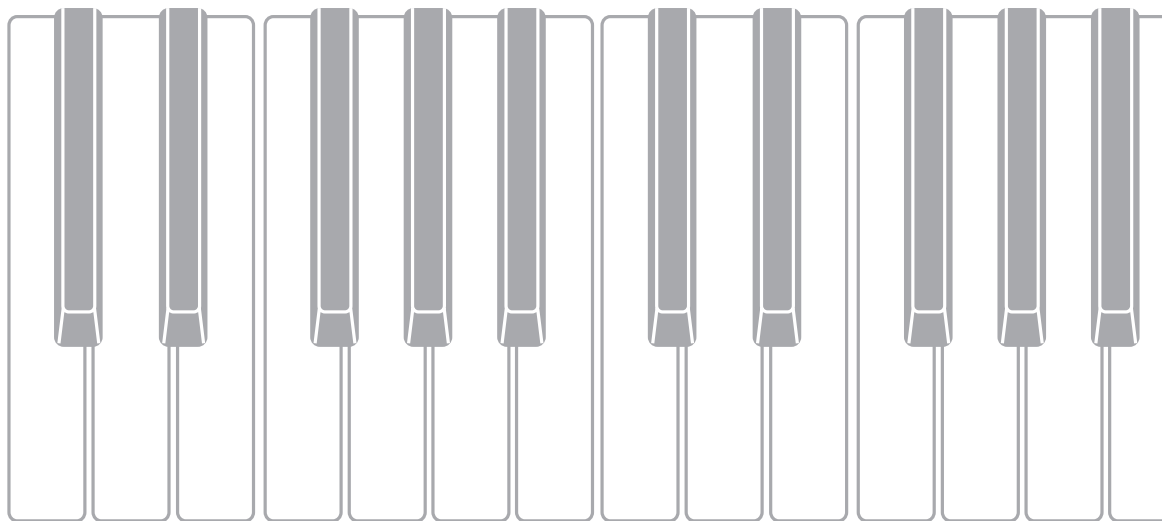

## **NOTICE**

This equipment has been tested and found to comply with the limits for a Class B digital device, pursuant to Part 15 of the FCC Rules. These limits are designed to provide reasonable protection against harmful interference in a residential installation. This equipment generates, uses and can radiate radio frequency energy and, if not installed and used in accordance with the instructions, may cause harmful interference to radio communications. However, there is no guarantee that interference will not occur in a particular installation. If this equipment does cause harmful interference to radio or television reception, which can be determined by turning the equipment off and on, the user is encouraged to try to correct the interference by one or more of the following measures:

- Reorient or relocate the receiving antenna.
- Increase the separation between the equipment and receiver.
- Connect the equipment into an outlet on a circuit different from that to which the receiver is connected.
- Consult the dealer or an experienced radio/TV technician for help.

## **FCC WARNING**

Changes or modifications not expressly approved by the party responsible for compliance could void the user's authority to operate the equipment.

## **Declaration of Conformity**

Model Number: XW-G1

Trade Name: CASIO COMPUTER CO., LTD.

Responsible party: CASIO AMERICA, INC.

Address: 570 MT. PLEASANT AVENUE, DOVER, NEW JERSEY 07801

Telephone number: 973-361-5400

This device complies with Part 15 of the FCC Rules, Operation is subject to the following two conditions:

(1) This device may not cause harmful interference, and (2) this device must accept any interference received, including interference that may cause undesired operation.

## **Important!**

Please note the following important information before using this product.

- Before using the optional AC Adaptor to power the unit, be sure to check the AC Adaptor for any damage first. Carefully check the power cord for breakage, cuts, exposed wire and other serious damage. Never let children use an AC adaptor that is seriously damaged.
- Never attempt to recharge batteries.
- Do not use rechargeable batteries.
- Never mix old batteries with new ones.
- Use recommended batteries or equivalent types.
- Always make sure that positive (+) and negative (-) poles are facing correctly as indicated near the battery compartment.
- Replace batteries as soon as possible after any sign they are getting weak.
- Do not short-circuit the battery terminals.
- The product is not intended for children under 3 years.
- Use only a CASIO AD-E95100L adaptor.
- The AC adaptor is not a toy.
- Be sure to disconnect the AC adaptor before cleaning the product.



This mark applies in EU countries only.



Manufacturer:  
CASIO COMPUTER CO., LTD.  
6-2, Hon-machi 1-chome, Shibuya-ku, Tokyo 151-8543, Japan  
Responsible within the European Union:  
CASIO EUROPE GmbH  
Casio-Platz 1, 22848 Norderstedt, Germany

- Any reproduction of the contents of this manual, either in part or its entirety, is prohibited. Except for your own, personal use, any other use of the contents of this manual without the consent of CASIO is prohibited under copyright laws.
- IN NO EVENT SHALL CASIO BE LIABLE FOR ANY DAMAGES WHATSOEVER (INCLUDING, WITHOUT LIMITATION, DAMAGES FOR LOSS OF PROFITS, BUSINESS INTERRUPTION, LOSS OF INFORMATION) ARISING OUT OF THE USE OF OR INABILITY TO USE THIS MANUAL OR PRODUCT, EVEN IF CASIO HAS BEEN ADVISED OF THE POSSIBILITY OF SUCH DAMAGES.
- The contents of this manual are subject to change without notice.
- The actual appearance of the product may be different from that shown in the illustrations in this User's Guide.
- Company and product names used in this manual may be registered trademarks of others.

# Contents

<b>General Guide .....</b>	<b>E-5</b>	Controlling Sounds .....	E-34
<b>Getting Ready to Play .....</b>	<b>E-8</b>	Using a Pedal .....	E-34
Connections .....	E-8	Using the Wheels (Bender, Modulation) .....	E-34
Power Supply .....	E-9	Using the Assignable Knobs .....	E-34
Using a Household Power Outlet .....	E-9	Using Sliders .....	E-34
Using Batteries .....	E-10	Using the Hold Button .....	E-36
Auto Power Off .....	E-10	Changing the Pitch of Notes in Semitone Steps (Transpose) or Octave Steps (Octave Shift) .....	E-36
Bundled and Optional Accessories .....	E-10	<b>Applying Effects to Notes .....</b>	<b>E-36</b>
<b>Learning to Play by Playing (For Synthesizer Novices) .....</b>	<b>E-11</b>	To configure effect settings .....	E-37
Playing with Built-in Tones .....	E-11	Saving an Edited DSP .....	E-39
Creating Tones .....	E-12	<b>Sounding Arpeggios Automatically .....</b>	<b>E-40</b>
Using the Step Sequencer and Phrases .....	E-13	To use the Arpeggio Function .....	E-40
Arpeggio Function .....	E-13	Editing an Arpeggio .....	E-41
Phrase Sequencer .....	E-14	Clearing Arpeggio Data .....	E-44
Step Sequencer .....	E-14	<b>Recording and Playing Back Phrases .....</b>	<b>E-45</b>
Recording and Looping a Sample .....	E-15	To play back a preset .....	E-45
Using the Performance Function .....	E-16	To change the tempo setting .....	E-46
Playing a Built-in Demo Song .....	E-17	You can use the phrase selection screen to select the recommended tone for the currently selected phrase as your Zone Part 1 tone. ....	E-46
Conclusion .....	E-17	To start phrase playback by pressing keyboard key (Key Play) .....	E-46
<b>Selecting and Creating Tones .....</b>	<b>E-18</b>	Recording a New Phrase .....	E-47
Overview .....	E-18	Phrase Data Settings .....	E-48
To select a tone .....	E-19	Recording Over Another Phrase (Overdubbing) .....	E-48
To edit and save a tone as a user tone .....	E-20	Indicators Next to Phrase Numbers .....	E-49
Editable Parameters for Solo Synthesizer Tone .....	E-21	To save a phrase .....	E-49
Editable Parameters for PCM Melody Tone (Non-drum PCM Tones) .....	E-30		
Editable Parameters for Drum PCM Tone .....	E-31		
Editable Parameters for User Wave Tone .....	E-32		

## **Using the Step Sequencer ..... E-50**

How the Step Sequencer is organized.....	E-50
Playing Back a Step Sequence.....	E-52
Editing a Sequence -Simple Editing.....	E-52
To turn a step on or off.....	E-53
To configure tied note settings.....	E-53
Using the Sliders to Change Note and Velocity Settings.....	E-53
Using the Master Slider to Change Note and Velocity Settings.....	E-54
Changing Slider Assignments.....	E-54
Changing the Function Assigned to the Master Slider.....	E-54
Inputting Step Data by Playing on the Keyboard, etc.....	E-55
Changing the Solo1 Channel.....	E-55
Changing the Timing of Pattern Switching.....	E-56
Syncing Step Sequencer Playback with an Arpeggio.....	E-56
Changing the Step Sequencer Tone.....	E-56
To sound a single part (solo mode).....	E-56
Editing a Sequence - Advanced.....	E-56
To perform advanced parameter editing.....	E-56
Changing Slider Settings.....	E-60
To copy slider settings from another slider.....	E-60
To save an edited sequence.....	E-61
Chaining.....	E-61
To create a chain.....	E-61
To play back a chain.....	E-62
To initialize chain settings.....	E-62
To save a chain in SMF format to a memory card.....	E-63

## **Recording and Playing Back with the Sample Looper ..... E-64**

Sample Recording.....	E-64
To record with the sample looper.....	E-64
To use the Step Sequencer to record a sample.....	E-69
To play back a sample.....	E-69
Indicators Next to Sample Numbers.....	E-70
To save a sample.....	E-70

## **Using the Performance Mode..... E-71**

Overview.....	E-71
Registering and Recalling Performances.....	E-71
To register a performance.....	E-71
To recall a performance.....	E-72
Editable Performance Parameter List.....	E-73

## **Other Useful Functions ..... E-78**

Using the Mixer.....	E-78
Instant Adjustment of Settings using the Sliders and Step Buttons.....	E-79
Mixer Settings.....	E-80
Global Synthesizer Settings.....	E-81
Tuning (Fine tuning of note pitch).....	E-81
Local Control.....	E-81
Master Coarse Tune (Tuning of note pitch in semitone steps).....	E-81
Initial Power On Mode.....	E-81
Display Contrast.....	E-81
Auto Power Off On/Off.....	E-81
Using MIDI.....	E-82
What is MIDI?.....	E-82
MIDI Settings.....	E-82
Deleting Data Saved on the Synthesizer.....	E-83
Initializing Synthesizer Global Settings and Data.....	E-84
Playing a Demo Tune or a File from a Memory Card.....	E-84

**Using a Memory Card..... E-86**

Supported Data Types ..... E-86

Card and Card Slot Precautions ..... E-87

Loading and Removing a  
Memory Card ..... E-87

Formatting a Memory Card ..... E-88

Saving Synthesizer Data to a  
Memory Card ..... E-88

    To save Synthesizer data to a memory card..... E-88

    To batch save all Synthesizer data to a  
    memory card ..... E-89

Loading Data from a Memory Card..... E-90

    To load data to Synthesizer memory from a  
    memory card ..... E-90

    To batch load all Synthesizer memory data  
    from a memory card ..... E-90

To delete a file from a memory card ..... E-90

To rename a file on a memory card ..... E-91

Playing a Music File from a  
Memory Card ..... E-91

**Connecting to a Computer ..... E-92**

Minimum Computer System  
Requirements ..... E-92

    Connecting the Synthesizer to Your Computer ..... E-92

Saving and Loading Synthesizer Data  
to a Computer and Editing Synthesizer  
Data on a Computer ..... E-93

**Reference ..... E-94**

Error Messages ..... E-94

Troubleshooting ..... E-95

Specifications ..... E-97

Operating Precautions ..... E-98

DSP Effect List ..... E-99

    DSP Type List ..... E-99

    DSP Parameter List ..... E-100

Supported Input Characters ..... E-103

**MIDI Implementation Chart**

# General Guide

- In this manual, buttons, knobs, terminals, and other parts are referred to using a combination of group numbers (1, 2, etc.) and part names.

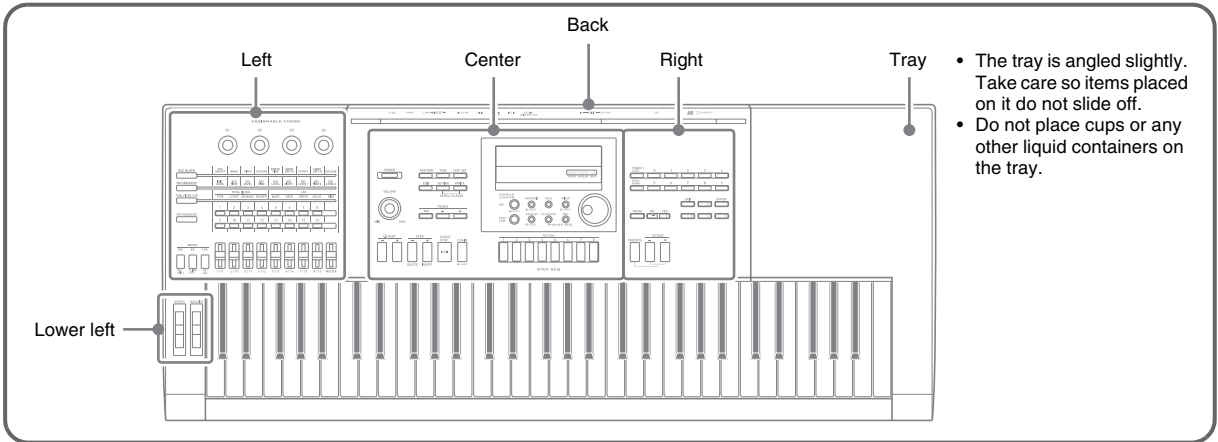

- The tray is angled slightly. Take care so items placed on it do not slide off.
- Do not place cups or any other liquid containers on the tray.

## Left

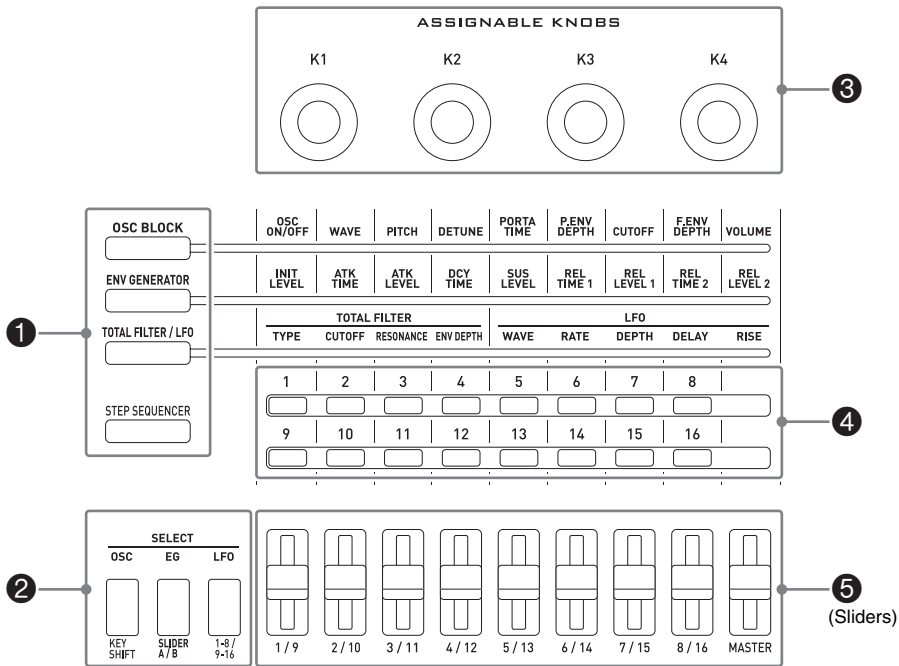

Groups 1 through 5 are laid out to facilitate adjustment of a sound as you listen to it.

- 1 Use these buttons to select the functions assigned to the sliders (5) and 2 buttons. [☞ Page E-34](#)
- 2 Use these buttons when editing Solo Synthesizer tones and to change parts assigned to the sliders (5). [☞ Page E-23](#)
- 3 Use these knobs to adjust attack, decay, and other sound parameters. [☞ Page E-34](#)
- 4 Use these buttons with the step sequencer to turn each step or part on or off. [☞ Page E-53](#)
- 5 Use these sliders to adjust parameters. They are also used for editing with the step sequencer and mixer. [☞ Page E-34, E-53, E-78](#)

## Center

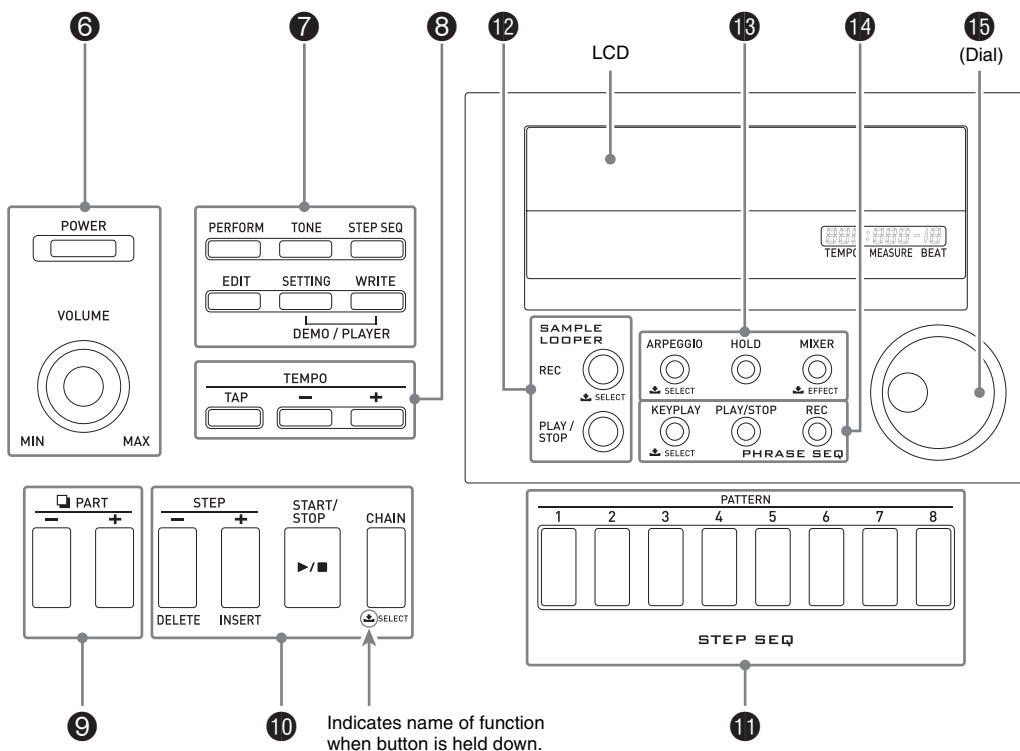



- ⑥ Use the [POWER] button to turn power on or off, and the [VOLUME] knob to adjust the volume level. [☞ Page E-9](#)
- ⑦ Use the top three buttons to select the Synthesizer's mode. Use the bottom three buttons to edit and save tone and other data, and to configure system-wide general settings. [☞ Page E-11, E-12, E-81](#)
- ⑧ Use these buttons to adjust the tempo of the step sequencer, phrase, and other playback. [☞ Page E-46](#)
- ⑨ Use these buttons to select a part for editing with the step sequencer or mixer. [☞ Page E-52, E-78](#)
- ⑩ Use these buttons to select a step for step sequencer playback or editing. [☞ Page E-52](#)
- ⑪ Use these buttons to select a step sequencer pattern. [☞ Page E-11, E-52](#)
- ⑫ Use these buttons for sample looper recording and playback. [☞ Page E-64](#)
- ⑬ Use these buttons to turn the arpeggio and hold functions on or off, and to change mixer or effect settings. [☞ Page E-37, E-40, E-78](#)
- ⑭ Use these buttons to perform phrase sequencer recording and playback. [☞ Page E-45](#)
- ⑮ Use the dial for quick change of the numbers and values that appear on the display. [☞ Page E-11](#)

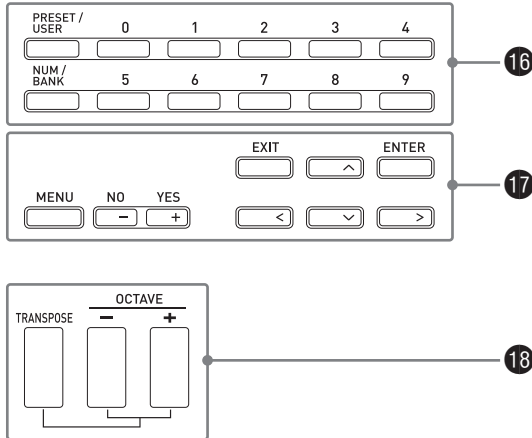

## Right



- 16 Use these buttons to select a tone number, performance number, etc.  Page E-19
- 17 Use the six buttons on the right to move the cursor on the screen, and the minus (-) and plus (+) buttons to change a displayed value. Press the [MENU] button to display a menu of options for the operation you are currently performing.  Page E-20
- 18 Use these keys for one-touch alteration of the pitch of a sound.  Page E-36

## Lower left

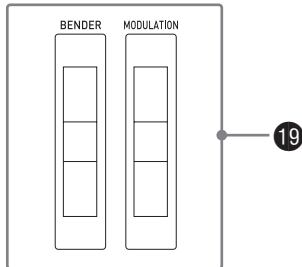

- 19 Use [BENDER] to bend notes and [MODULATION] to add vibrato to notes.  Page E-34

**Back** See the next page.

# Getting Ready to Play

## Connections

- Whenever you connect any device to the Synthesizer, be sure to read the user documentation that comes with the device.
- This Synthesizer does not have built-in speakers. It will not produce sound unless you connect some device for sound output.

### 20 Back left

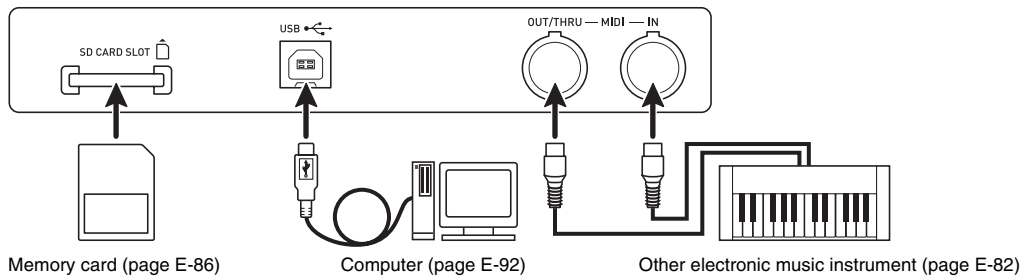

### 21 Back right

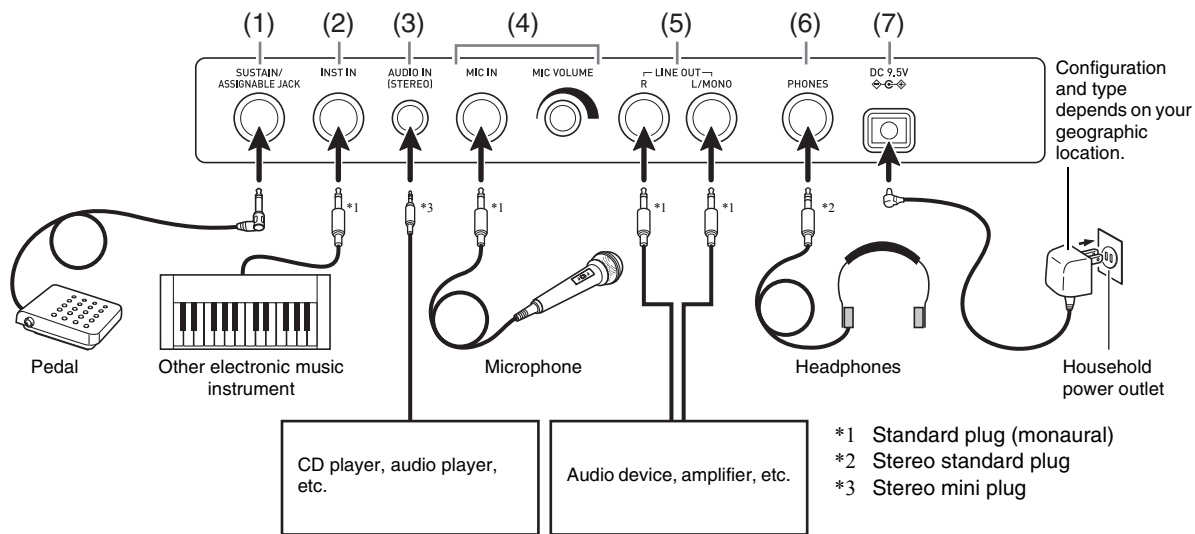

	To do this:	Do this:
(1)	Use a pedal	Connect an optionally available sustain pedal. For information about the type of effect applied when the pedal is depressed, see page E-74.
(2)	Input sound from another electronic musical instrument	Use a commercially available connecting cord to connect the output terminal (monaural) of the other instrument to the Synthesizer.*4 <ul style="list-style-type: none"> <li>You can also apply effects to input sounds (page E-36) and use input sounds when creating new tones as part of the Synthesizer's tones (page E-21).</li> </ul>
(3)	Input from an external device	Use a commercially available connecting cord to connect the output terminal (stereo) of a CD player or portable audio player to the Synthesizer.*4
(4)	Input external sound using a microphone	Connect a commercially available dynamic microphone to the Synthesizer.*4 You can use <b>21 MIC VOLUME</b> to adjust sound input with the microphone independently of other sound. <ul style="list-style-type: none"> <li>For information about applying effects to sound input with a microphone, see page E-78. For information about using input sounds for tone creation, see page E-21.</li> </ul>
(5)	Output Synthesizer sound using audio equipment or an amplifier	Use a commercially available connecting cord to connect the input terminal (AUX IN, etc.) of the audio equipment or amplifier to the Synthesizer.*4 <ul style="list-style-type: none"> <li>For monaural output with a single connecting cord, connect the cord to the L/MONO terminal of the Synthesizer.</li> </ul>
(6)	Use headphones	Connect optional or commercially available headphones to the Synthesizer.*4 <ul style="list-style-type: none"> <li><u>Do not listen to music at very loud volumes for long periods. Doing so creates the risk of hearing damage.</u></li> </ul>
(7)	Supply power to the Synthesizer	See "Power Supply" below.

\*4 Before connecting, be sure to turn off power to the Synthesizer and the device being connected, and turn **6 VOLUME** down to a low level.

## Power Supply

Prepare a household power outlet or batteries.

### IMPORTANT!

- Be sure to comply with the separate "Safety Precautions". Incorrect use of this product creates the risk of electric shock and fire.
- Always make sure that the product is turned off before plugging in or unplugging the AC adaptor, or before loading or removing batteries.

### Using a Household Power Outlet

Make sure that you use only the AC adaptor (JEITA Standard, with unified polarity plug) specified for this product. Use of a different type of AC adaptor can cause malfunction.

Specified AC Adaptor: AD-E95100L

- Use the AC adaptor specified for this Synthesizer to connect it to a household power outlet.

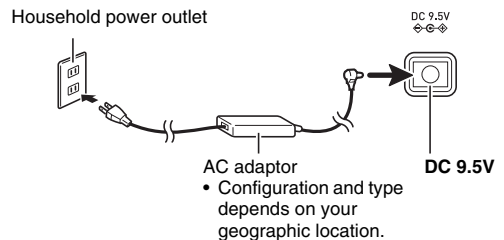

- Press **6 POWER** to turn on power.

- To turn off power, press **6 POWER** again.

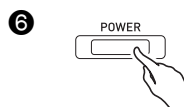

## IMPORTANT!

- If you press **ⓐ** POWER only lightly, the display will light up momentarily but power will not turn on. This does not indicate malfunction. Press **ⓐ** POWER firmly and completely to turn on power.
- The AC adaptor will become warm to the touch after very long use. This is normal and does not indicate malfunction.
- To prevent breaking of the wire, take care to avoid putting any type of load on the power cord.

No bending!



No winding!

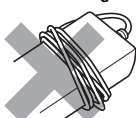

- Never insert metal, pencils, or any other objects into the product's 9.5V DC terminal. Doing so creates the risk of accident.

## Using Batteries

You can use six D-size batteries for power.

- Use alkaline or zinc-carbon batteries.
- Never use oxyride or any other nickel based batteries.

### 1. Open the battery cover on the bottom of the Synthesizer.

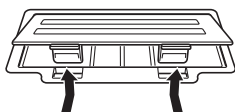

### 2. Load six D-size batteries into the battery compartment.

- Make sure the positive  $\oplus$  and negative  $\ominus$  ends of the batteries are facing as shown in the illustration.

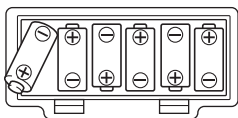

### 3. Insert the tabs of the battery cover into the holes on the side of the battery compartment, and close the cover.

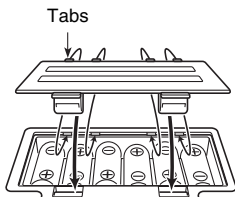

### 4. Press **ⓐ** POWER to turn on power.

## Low Battery Indication

The following shows the approximate battery life.

**Approximately 35 hours\*** (alkaline batteries, using the optional CASIO CP-16 headphones)

- \* Using a high volume setting, playing in very low temperatures, and certain other playing conditions can shorten battery life.

Low battery power is indicated when the message "Battery Low" appears and the indicators shown below flash on the display. Replace the batteries with new ones.



Low battery indication (flashing)

## Auto Power Off

The Synthesizer turns off automatically to avoid wasting power if no operation is performed for a preset amount of time. The Auto Power Off trigger time is six minutes under battery power and four hours under AC adaptor power.

- You can disable Auto Power Off by turning off the "Auto Power Off" setting as described under "Global Synthesizer Settings" (page E-81).

## Bundled and Optional Accessories

Use of unauthorized accessories creates the risk of fire, electric shock, and personal injury.

### NOTE

- You can get information about accessories that are sold separately for this product from the CASIO catalog available from your retailer, and from the CASIO website at the following URL.

<http://world.casio.com/>

# Learning to Play by Playing (For Synthesizer Novices)

This chapter gets you started with basic operations by actually using the Synthesizer, while avoiding getting too bogged down in theory and technical details. It is the perfect place to start for those who are using a synthesizer for the first time.

So, let's get started!

## Playing with Built-in Tones

Press **6** **POWER** to turn on power. The Synthesizer initially enters its Performance Mode.

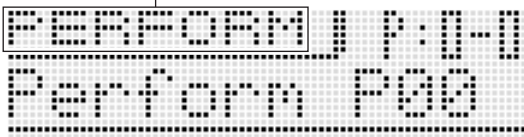
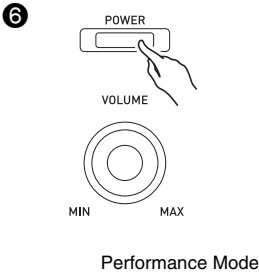

The Performance Mode is great for tapping to the full power of the Synthesizer during performances, but it is a bit too advanced for our basic explanation here. For now, let's start out with some basic operations in the Tone Mode.

Press **7** **TONE** to enter the Tone Mode.

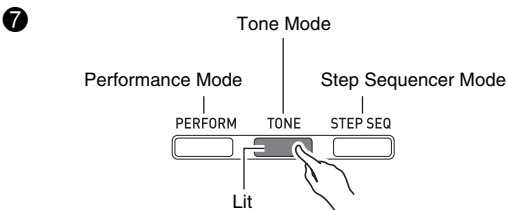

## Three Synthesizer Modes

Performance Mode	Use this mode for playing and performing. It enables high-level performance with tone categories, a Step Sequencer, and more.
Tone Mode	Use this mode for tone creation. You can select a single tone and edit it the way you want.
Step Sequencer Mode	This mode is for creating step sequencer data (sets).

Here, let's select a tone hear what it sounds like.

Tones are divided among four categories. Rotate the **15** dial to select the tone number you want. Alternately, you could also use the **15** buttons to input specific tone numbers (page E-19).

Category		Overview
Number	Name	
P000 to P099	Solo Synthesizer	Traditional analog synthesizer tones
P100 to P399	PCM Melody Tone PCM Drum Tone	These tones let you use sampled sounds to reproduce the sounds from a variety of different instruments.
-	User Wave Tone	Save of tones recorded with the sample looper.

• For more information, see page E-19.

First, let's see what a Solo Synthesizer tone sounds like. Rotate the **15** dial to select a tone number.

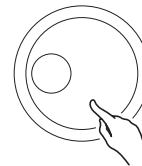

Play something on the keyboard to hear what the tone sounds like. Use **6 VOLUME** to adjust the volume.

- Note that the Solo Synthesizer tones are monophonic. If you press multiple keys, only the note of the last key pressed will sound.



Solo Synthesizer actually is a category that contains 100 built-in (preset\*) tones. What we played here is just one of them. Now let's play some more of the preset tones in this category.

\* There are also "user tones" which are those that you create and store for later recall. The terms "preset" and "user" are also used for other types of data, such as Step Sequencer data, performance data, etc.

Press the **17 plus (+) button**. Each press increases the preset tone number and changes the tone setting.

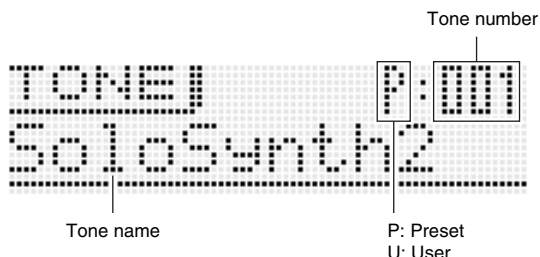
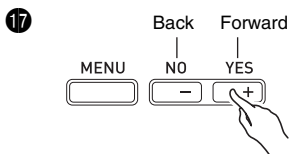

You can use the same operations to select the tones in the other categories besides Solo Synthesizer, so experiment for yourself to find out what tones are available.

## Creating Tones

Tone creation is actually what using a synthesizer is all about. Starting from a preset tone, you can change various parameters to create a tone that is your own original sound.

With this setting, pressing the **7 EDIT button** provides you with a collection of powerful editing capabilities (page E-20). In addition, you also can use the **5 sliders** to easily alter tones without using the **7 EDIT button**. Here we will take a simplified look at editing a Solo Synthesizer tone. This process is covered in greater detail later in this manual.

Press **7 TONE** and then rotate the **15 dial** to select a tone number.



Play some notes on the keyboard. As you do, rotate the **3 ASSIGNABLE KNOBS**. This will change the characteristics of the tone that is sounding. Make adjustments until the tone sounds the way you want.

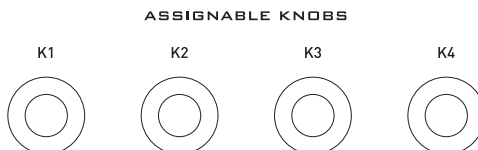

Example: Rotating K1 while P:000 is selected as the tone

- Rotate right to make the tone brighter.
- Rotate left to make the tone darker.

After you are finished, you can save the result as a user tone.

Press **7 WRITE** to enter the save mode. The save destination will appear on the display screen.

Save destination  
U: User number  
000: Tone Number 000

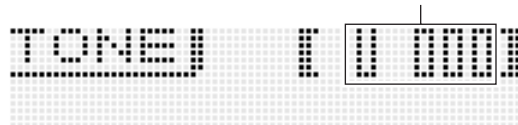

Use the **15 dial** or **17 minus (-) and plus (+) buttons** to specify the tone number where you want to save your user tone.

Next, press the **17** down (∨) button to change to the tone name input screen.

Example:



Cursor: Input position

Use the **17** left (<) and right (>) buttons to move the cursor between input positions, and the **16** tone number buttons to input characters.

- The illustration below shows the letters that each of the **16** tone number buttons inputs. Each press of a button cycles through the letters or toggles between the settings assigned to it. For information about what types of characters are supported, see page E-103.

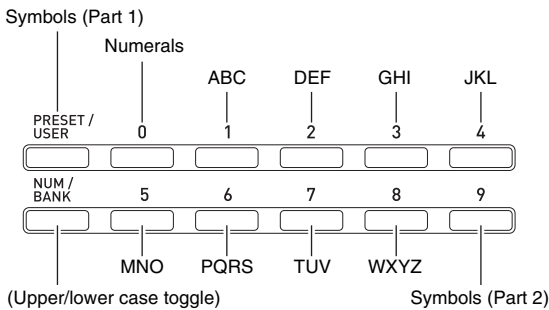

- You also can use the **17** minus (-) and plus (+) buttons or the **15** dial to scroll through characters.

After the tone name is the way you want, press **17** ENTER. This will cause “Replace?” (Do you want to replace the current tone?) to appear on the display.\*1

Press **17** YES to save the user tone.\*2

- \*1 Saving data to a tone number deletes any data that was previously assigned to that number.
- \*2 If you do not want to save the data, press **17** NO instead of YES.

- We recommend that you back up all data stored in Synthesizer memory to a memory card or a computer hard disk. To save data to a memory card, see “Using a Memory Card” (page E-86). To save data to a computer, see “Connecting to a Computer” (page E-92).

To recall a stored user tone, use the same procedure as that for recalling preset tones. Let’s try recalling the tone we just saved.

- Before specifying the tone number, press **16** PRESET/USER to enter the user tone select mode.

**16** Lit (Indicates user tone selected.)

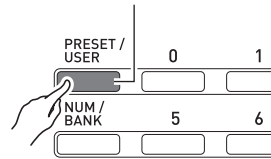

At this point you have mastered the simplest steps required to edit and save tones. But you shouldn’t stop here. Your Synthesizer has a wealth of other tone editing features, functions, and tools. Take the time to learn about these and you will become capable of high-level tone editing. Find out more under “Selecting and Creating Tones” on page E-18.

## Using the Step Sequencer and Phrases

Your Synthesizer does much more than create tones. It is also equipped with a collection of functions that support uniquely expressive rhythms and phrases that enhance your performances. This section provides a simple introduction to some of these functions.

### Arpeggio Function

Press **13** ARPEGGIO so the button becomes lit.

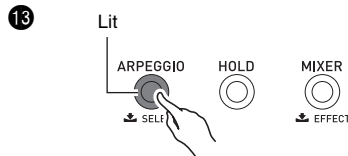

Press any key on the keyboard. The arpeggio function will cause the note assigned to the key to play in an endless loop. The loop will stop when you release the keyboard key. Pressing two or three keyboard keys will loop play the notes of the keys you press. Pressing three or more keys will cause an arpeggio (sometimes referred to as a “broken chord”) to be played.

There are a variety of different built-in arpeggio types. You can select one the same way as you select a preset tone, edit it, and then save it as a user arpeggio type. Let's go over the procedure for selecting a preset arpeggio type.

- The arpeggios of this Synthesizer are divided into 10 type groups called "banks". There are a total of 10 arpeggio banks numbered 0 through 9, with 10 arpeggios in each bank for a total of 100 arpeggios.

Hold down **13 ARPEGGIO** until the screen shown below appears on the display.

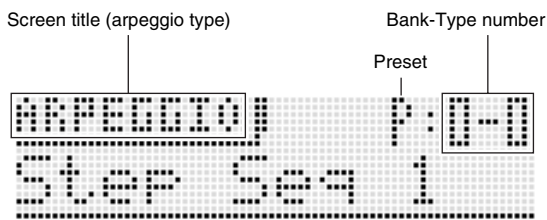

Now rotate the **15 dial** and select a preset phrase type the same way you select a tone (page E-11). For details about arpeggios, see "Sounding Arpeggios Automatically" on page E-40.

## Phrase Sequencer

To give you an idea about what a musical phrase is, let's listen to a preset phrase.

Hold down **14 KEY PLAY** until the screen shown below appears on the display.

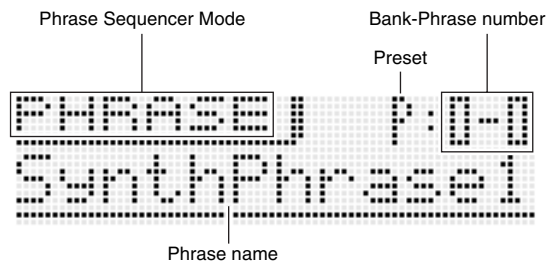

Press **14 PLAY/STOP**. This will start playback of one of the Synthesizer's built-in preset phrases. Next, try rotating the **15 dial** and selecting other preset phrases.

Instead of using **14 PLAY/STOP**, you can also start playback of a phrase by pressing a key on the keyboard. Let's see how this works.

First, press **14 KEY PLAY** so the button becomes lit.

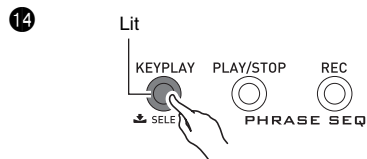

This is Key Play Mode. Pressing a keyboard key while in the Key Play Mode will automatically start playback of a phrase. Pressing another key will play the phrase using a different pitch. In the Key Play Mode, the keyboard can be used to sequentially play a phrase at different pitches to create an interesting effect.

The Phrase Sequencer main chapter covers information about how you can record your own phrases and play them back when you want to. For more information see "Recording a New Phrase" on page E-47.

## Step Sequencer

Let's start out our explanation of the Step Sequencer by listening to some preset sequence data.

Press **7 STEP SEQ** to enter the Step Sequencer Mode.

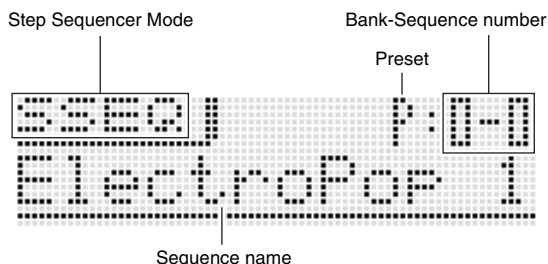
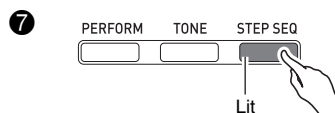



As you do when selecting a tone, you can use the **15** dial to select the sequence you want. For now, let's select preset sequence 2-3, and then press **10** **START/STOP**. This will start playback of the sequence you selected.

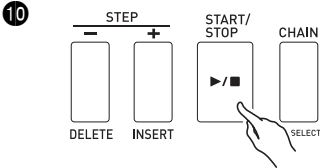

Each sequence has eight variations (patterns), which you can select using the **11** **PATTERN 1 to 8** buttons. Experiment with selecting the various patterns to get an idea of what is available.

Example: To select Pattern 3

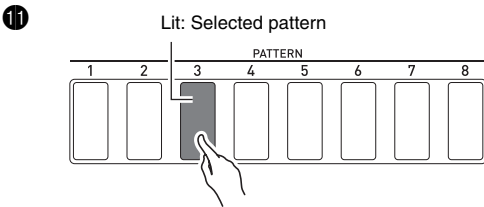

The Step Sequencer uses nine (8 through 16) of the 16 parts of the Synthesizer's sound source, which provides plenty of support every for very complex rhythms. You can find out which parts are outputting sound at any time by checking the level meter on the Synthesizer's display.

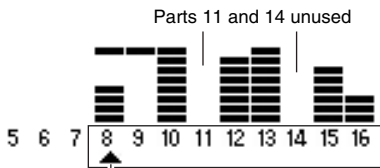

As the sequence plays back, the **4** buttons (1 to 16) continually turn on and off, which indicates the movement of the notes of the part that is being edited (the part indicated by the pointer (▲) in the illustration above. This is the way the Step Sequencer repeatedly produces the 16 steps. You can select a part for editing using the **9** **PART minus (-) and plus (+) buttons**. Use the **5** slider to edit individual steps. For more information, see page E-50.

What we have seen here is just a very small part of the many and varied rhythms that can be produced by your Synthesizer. Be sure to take a look at the procedure under "Using the Step Sequencer" on page E-50 to find out how you can create your own original sequences.

## Recording and Looping a Sample

The following shows an simple example of how to use the sample looper to sample a sound and create a loop.

Connect the other electronic music instrument from which you want to record the sample or a microphone to the Synthesizer. (See page E-8.)

Press **12** **REC** to display the LOOPER REC (sample looper recording setting) screen.

- Use the **17** cursor (▲, ▼) buttons and the **17** minus (-) and plus (+) buttons to change the "Rec Mode" setting to "NORM-AT" and the "Length" setting to "04bt".

REC mode setting screen

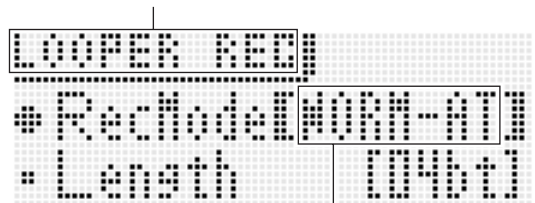

Auto REC mode

Press **12** **REC** again.

This will cause the **12** **REC** button to flash. This operation will enter the record auto start mode.

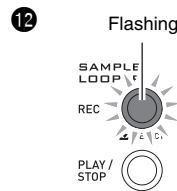

Output the sound on the other electronic music instrument or microphone, or play something on the Synthesizer. The Synthesizer will detect the sound and start recording.

- The **12** **REC** button lights when recording starts.

After recording of four beats is complete, playback of a loop of what was recorded starts automatically.

- The **12** **REC** button starts flashing at high speed and overdubbing is paused. Anything you play at this time is not overdubbed into the sample, so you can play a duet with what you recorded previously or practice for future overdubbing.

When you are ready to start overdubbing, press **12** **REC** again. so the **12** **REC** button light stops flashing and remains lit.

- Whatever you play at this time is overdubbed on what you recorded previously.
- Each press of **12** **REC** toggles between loop playback and overdubbing.

To stop recording, press **12** **PLAY/STOP**.

For details, see "Recording and Playing Back with the Sample Looper" (page E-64).

## Using the Performance Function

If you have read all of the information in this introductory part of the manual, you are finally ready to start using the Performance function. In the Tone Mode, you saw how you can select a single tone and play it on the keyboard. In the Performance Mode, you can perform with up to four tones simultaneously. You also can use the Performance Mode to register tone, Step Sequencer, and other settings as setup called a "Performance". A Performance can be recalled at any time, even while you are playing, to instantly change the sequencer's setup.

Press **7** **PERFORM** to enter the Performance Mode.

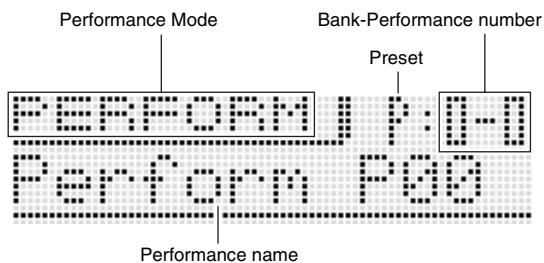
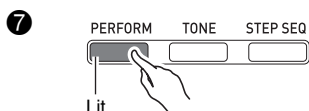

The Performance Mode keyboard uses the four tones selected as Zone Part 1 through 4. For more information about zone parts and their tones, see "Selecting and Creating Tones" on page E-18.

- Solo Synthesizer tones can be assigned to Zone Part 1 only.

Always configure Zone Part 1 first. Press **7** **PERFORM** and **7** **TONE** at the same time to enter the Quick Tone Mode, which you can use for simple Performance editing.

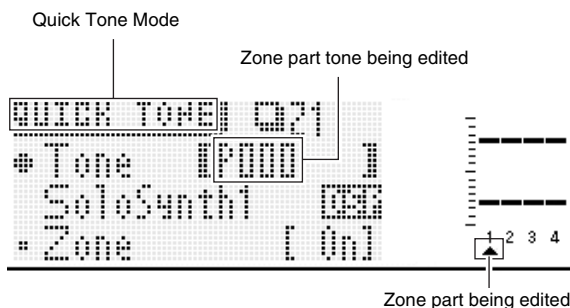
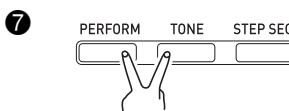

If the pointer ( $\blacktriangle$ ) on the display is not under 1, use the **9** **PART minus (-) and plus (+) buttons** to move it to 1. After ensuring that the pointer ( $\blacktriangle$ ) is located at 1, use **11** **15** **16** **17** to select the tone for Zone Part 1.

Next, use the **9** **PART minus (-) and plus (+) buttons** to move the display pointer ( $\blacktriangle$ ) to 2 and then use the same procedure as above to select a tone for Zone Part 2. Repeat the above step for Zone Parts 3 and 4.

After selecting tones for each of the zone parts, **17** **EXIT** to return to the Performance Mode screen. Next, play something on the keyboard to see what it sounds like. All four of the tones that you selected above should sound.

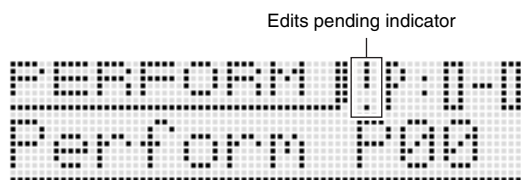

The exclamation point (!) indicator on the display indicates that there are pending edits that have not been saved yet. Press **7** **WRITE** to enter the save mode. Next, perform the same procedure that you used when saving a user tone to save your user Performance data.

Example: To save the performance to User Bank 2, Performance 1

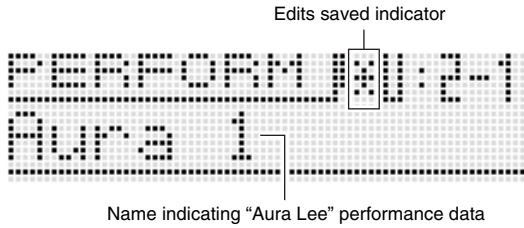

**NOTE**

- The edits pending indicator (!) and edits saved indicator (\*) are also used in other modes where data is edited and saved (tones, Step Sequencer, etc.)

When you want to perform the song “Aura Lee”, simply recall User Performance 2-1 to instantly configure the Synthesizer with the four tones you registered above. Try recalling a different Performance number and then recall User Performance 2-1.

In addition to keyboard tones, you also can register a variety of other settings as Performance data. An effective way to use banks would be as song-specific banks. For example, Bank 2 for “Aura Lee”, Bank 3 for another song, etc. For more information, see “Using the Performance Mode” on page E-71.

## Playing a Built-in Demo Song

Use the procedure below to play a built-in demo song that shows off the full versatility of the Synthesizer.

Press **7** **SETTING** and **7** **WRITE** at the same time.

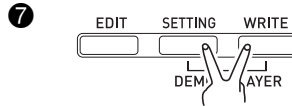

Next, press **17** **ENTER**. This will start demo tune play.

- Use the **17** **minus (-) and plus (+) buttons** to select a different tune, and **10** **START/STOP** to stop demo tune play. For more information, see page E-84.

## Conclusion

Tone number and other settings you configure on the Synthesizer are retained even when you turn power off. For information about returning settings to their initial defaults, see “Initializing Synthesizer Global Settings and Data” on E-84.

This completes the section for synthesizer novices. See the other sections of this manual for detailed information about the topics covered briefly in this section. Take your time and don’t rush, making sure you fully understand as you go along. If you have problems with any of the terms used in this manual, you can find more information by searching on the Web or by consulting a reference book about synthesizers or electronic music.

**Soon you will be well on your way enjoying the full potential of sound creation!**

# Selecting and Creating Tones

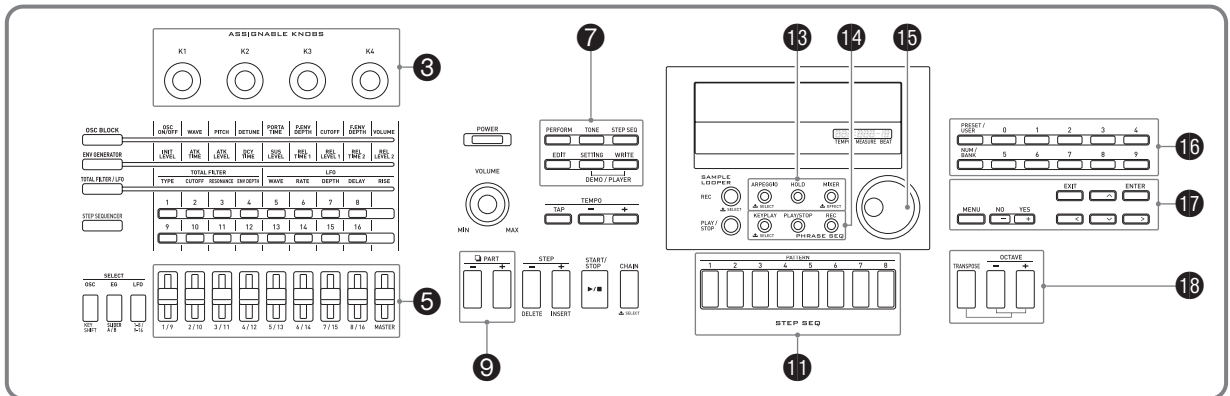

## Overview

The tones of this Synthesizer are made up of the 16 parts shown below, plus externally input parts. This chapter explains how to select, edit, and save tones using Zone Part 1\* in the Tone Mode (page E-11). It also covers the Effect Function that can be used to enhance tones and controllers that can be used to make various changes in a tone as you play.

Part Number	Part name	Features
1	Zone Part1*	This is the Synthesizer's main part. This part is played whenever you play on the keyboard. You can select the tone assigned to Zone Part 1 and edit the currently assigned tone.
2 to 4	Zone Parts 2 through 4*	These parts can be played only in the Performance Mode. Compared with Zone Part 1, your ability to assign and edit the tones assigned to these parts are limited (page E-71).
5 to 6	Multi-function Key	These parts are used by Phrase 1 (Part Number 5) and Phrase 2 (Part Number 6), which are assigned by the Multi-Function Key function (page E-73).
7	Guide, Precount	Used by the guide and/or precount when recording a phrase (page E-47).
8 to 16	Drum 1 to Chord	Step Sequencer Note Parts (page E-40).
-	External Input	These are tones that are input via the <b>21 MIC IN, INST IN jacks</b> (page E-78).

\* About zones and zone parts  
 Keyboard, pedal, button, and other operations not only affect the Synthesizers preset tones, they are also sent as MIDI data and affect any external device (electronic musical instrument or computer) connected to the Synthesizer.  
 The settings that apply to both internal and external parts are collectively referred to as a "zone" while the parts of the Synthesizer's built-in sound source that correspond to a zone is called "zone parts". For example, if you select a tone with Synthesizer Zone 2, that tone can be the part that corresponds to both the internal sound source Zone Part 2 or MIDI Channel 2 of an external device.

- You can change the relationships between zones and MIDI channels (page E-73).

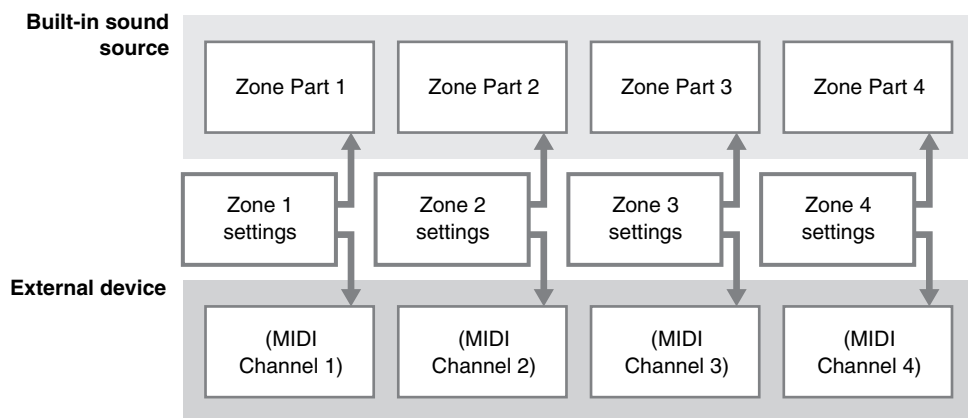

## To select a tone

### 1. Press **7** TONE.

The button will light and the Synthesizer will enter the Tone Mode.

### 2. Press **15** PRESET/USER to select preset tones or user tones.

- Preset tones are selected while the button is unlit, while user tones are selected while the button is lit.

### 3. Use the **16** number buttons (0 to 9) to input a tone number.

- You also can select a tone number by rotating the **15** dial.
- One more way to change the tone number is to use the **17** minus (-) and plus (+) buttons to decrease or increase the displayed number. Pressing the **17** minus (-) and plus (+) buttons at the same time will jump to the first tone in the current selected category (see next section).

## ■ Tone Category Overview

Category		Name	Description	Number of Tones	
Number				Preset	User
Preset	User				
P000-P099	U000-U099	Solo Synthesizer	This category contains traditional analog synthesizer tones. You can select a waveform as a base, and then edit the three elements of a sound (pitch, tone, volume) to create exactly the sound you want. Monophonic.	100	100
P100-P399	U100-U199	PCM Melody Tone	The tones in this category let you use sampled sounds to reproduce the sounds from a variety of different instruments.	300	100
P400-P419	U300-U309	PCM Drum Tone		20	10
-	U200-U210	User Wave Tone	Edits the wave of a sound recorded with the sample looper (page E-64). The wave of a sound can be edited and saved as a user wave tone. <ul style="list-style-type: none"> <li>• User wave tone U210 is a tone that is changed in real-time by sample looper recording.</li> </ul>	-	11

- See the separate “Appendix” for a complete list of tones.

## To edit and save a tone as a user tone

### 1. Select the tone you want to edit.

- You can select a preset tone or an existing user tone for editing.

### 2. Press **7** EDIT.

This will display the top screen of the tone editing list.

Example: First page of the Solo Synthesizer tone editing list

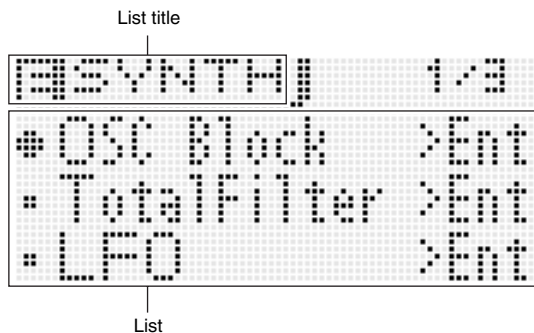

### 3. Use **17** to select the item you want and change the selected setting.

- You also can change setting by rotating the **15** dial.
- For details about the displayed contents, see the information presented for each tone category in the sections of this manual from “Editable Parameters for Solo Synthesizer Tone” (page E-21) to “Editable Parameters for User Wave Tone” (page E-32).

Example: To select the “Volume” item on the top screen and change its setting to 055

The options on this screen are groups, which are made up of multiple items. Selecting a group and pressing **17** ENTER will enter the group.

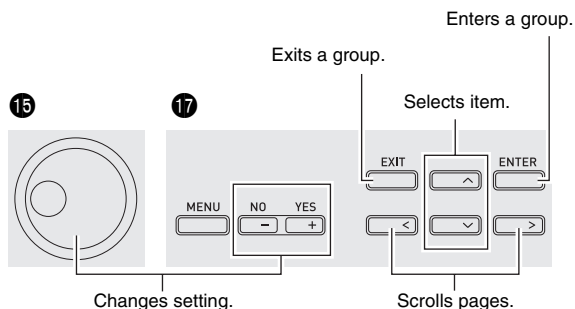
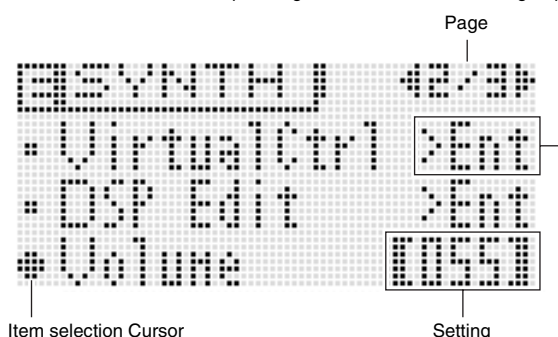

### 4. After you finish with your edits, press **7** EDIT.

This exits the tone editing list.

- The edits pending indicator (!) on the display indicates that there are pending edits that have not been saved yet. Your edits will be lost if you change to another operation without saving them. Advance to step 5 below if you want to save your edits.

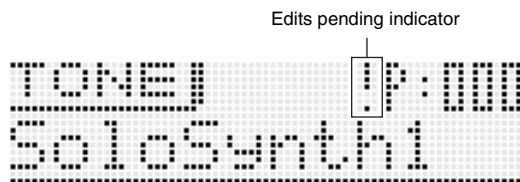

### 5. Press **7** WRITE and then save your edited tone as a user tone.

- For information about how to save user data, see the procedure for saving user tone data (page E-12).
- For information about how to delete user tones, see page E-83.

#### NOTE

- The settings of some of the items on the tone editing list can be changed using the Synthesizer’s sliders, without going through the tone editing list. See “Controlling Sounds” in the next section.

#### ■ Saving User Tones to an External Device

- Memory card (page E-86)
- Computer (page E-92)

## Editable Parameters for Solo Synthesizer Tone

Solo Synthesizer tones are synthesized by combining tones of the six blocks, number (1) through (6), in the illustration below. Before actually getting into tone editing, you should spend a little time becoming familiar with the structure and the details of each block.

### ■ Solo Synthesizer Tone Configuration Diagram

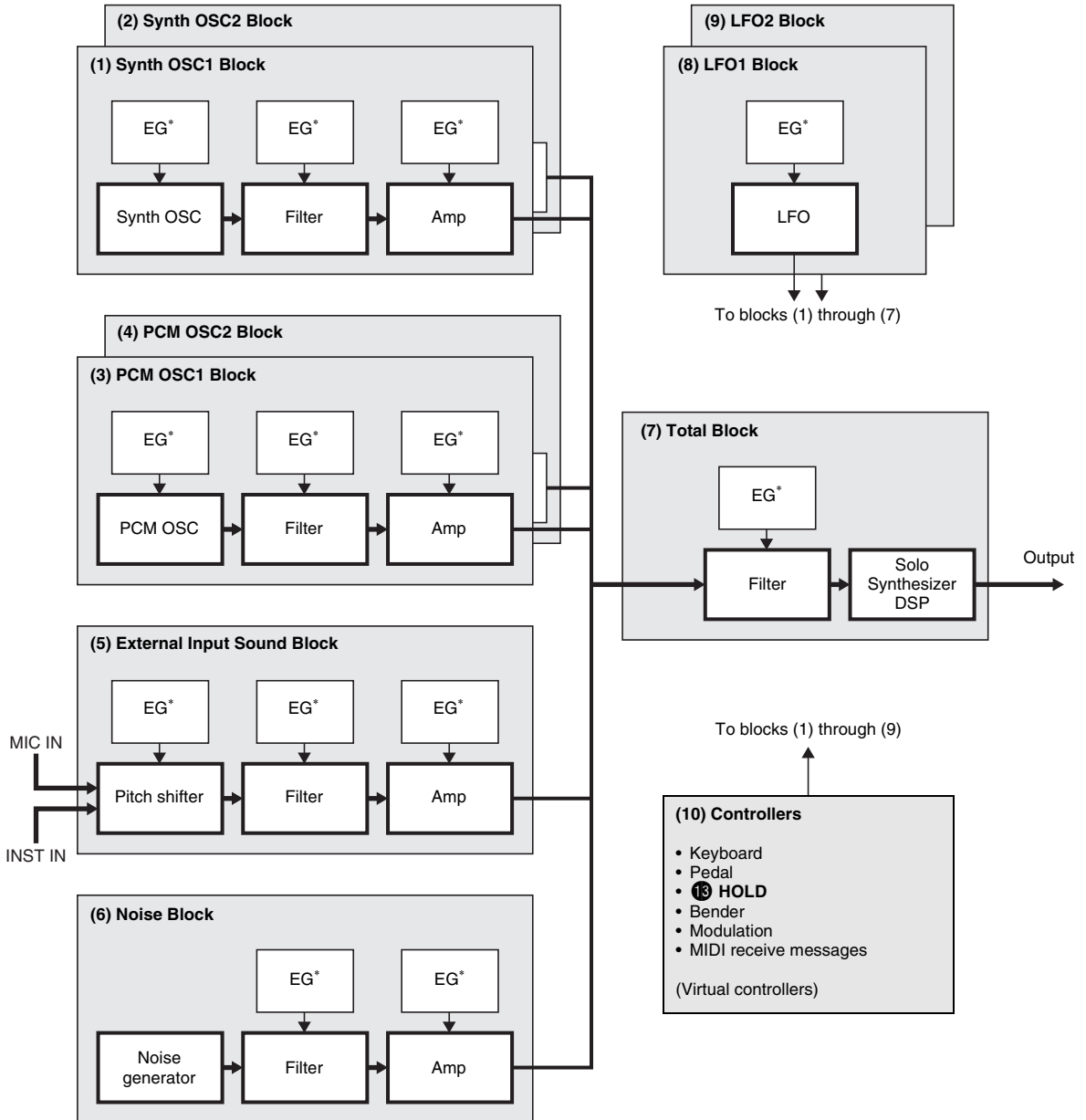

\* Envelope Generator

	Description
(1) Synthesizer OSC1 Block	<p>"OSC" is an abbreviation of "oscillator", which is where a sound is actually produced. These two synth OSC blocks creates sound using a sine wave, sawtooth wave, or other base waveform, just like an analog synthesizer.</p> <ul style="list-style-type: none"> <li>• Synth OSC: Generates the base sound and determines the pitch.</li> <li>• Filter: Cuts some of the frequencies to adjust timbre.</li> <li>• Amp: Adjusts volume.</li> <li>• Three EG (envelope generators):</li> </ul>
(2) Synthesizer OSC2 Block	<p>Control changes in pitch, timbre, volume, and other parameters over time. The nearby illustration shows an example of a volume envelope.</p>
(3) PCM OSC1 Block	<p>This block creates sound based on PCM sounds (same sound quality as sounds in the PCM Tone category). For information about how the editable parameters of this block differ from those for the OSC blocks above, see "Editable Parameters of Blocks (1) through (6)" (page E-23).</p>
(4) PCM OSC2 Block	
(5) External Input Sound Block	<p>Instead of an oscillator, this block creates sound based on sound input through the Synthesizer's <b>MIC IN and INST IN jacks</b>. The pitch change range of sound produced by this block is limited.</p>
(6) Noise Block	<p>Instead of an oscillator, this block creates sound based on noise generated by a special noise generator. The pitch of sound produced by this block cannot be edited.</p>
(7) Total Block	<p>This block combines signals (1) through (6) and sends the completed tone to the filters and DSP (a type of effect).</p>
(8) LFO1 Block	<p>"LFO" is an abbreviation of "low-frequency oscillator". The LFOs send waveform information to each block that is used as the basis for modulation, tremolo and other reverb effects.</p>
(9) LFO2 Block	
(10) Controllers	<p>Controllers include the keyboard, bender, and other controllers, as well as MIDI messages. Control messages are sent to blocks (1) through (9) to control tones. A virtual controller function can be used to freely configure combinations of controller types (sources) and the parameters being controlled (destinations) to perform such actions as "pedal depressed, change volume".</p>



**■ Editable Parameters of Blocks (1) through (6)**

- The **nine sliders (5)** and **four knobs (3)** can be used for quick and easy adjustment of some of the parameters in the list below (page E-34).

**Preparation**

Perform the following steps from the screen in step 2 of the procedure under “To edit and save a tone as a user tone” on page E-20.

1. Select “OSC Block >Ent” and then press **17** ENTER to enter the group.
2. Use the **9** PART minus (–) and plus (+) buttons to select the block you want to edit.

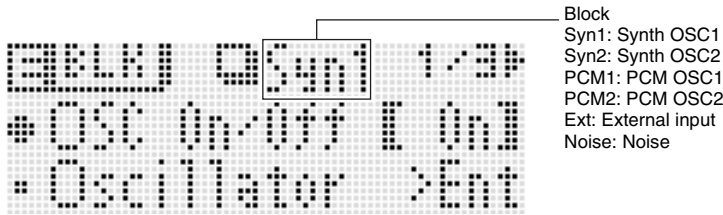

**Editable Parameter List**

- Shaded cells indicate a group made up of multiple items. Press **17** ENTER to display the items that make up a group.
- (V) at the end of a display item indicates an item that can be selected as a Block (10) virtual controller destination (page E-29).

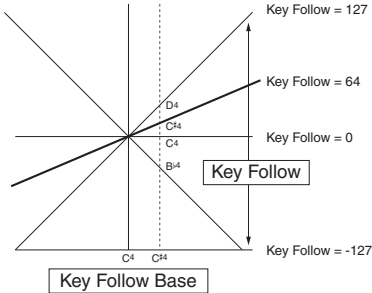
Display Text	Description	Settings
OSC On Off	OSC on/off. Selecting off disables the entire block.	Off, On
Oscillator >Ent (Block (1) to (5) only)	Oscillator. Group of editable parameters associated with the pitch of the synth OSC, PCM OSC, and pitch shift. • This group can be entered by performing step 1 under “To edit and save a tone as a user tone” (page E-20) and then holding down <b>7</b> EDIT.	
Synth Wave (Blocks (1) and (2) only) PCM Wave (Blocks (3) and (4) only)	Synth wave, PCM wave. Selects the base wave for a sound generated by the synth OSC or PCM OSC. • A wave whose name is displayed with “L” or “B” next to it will sound at a pitch that is one octave lower than the actual pitch. In the case of a “B” wave, nothing will sound when a keyboard key higher than C5 is pressed. • See the separate “Appendix” for details about wave types. • This item is not present in Block (5). • The splits of a user wave tone (User Wave) can be assigned as PCM waves. User wave names consist of the text “UserWave”, followed by two number separated by a hyphen (such as: UserWave 1-2). The number to the left of the hyphen (1 in the example), is a user number from 1 to 10 or the letter R (sample looper recorded data). The number to the right of the hyphen (2 in the example), is a split number from 1 to 5. If the data includes a wave, an asterisk (*) is appended to the beginning of the user wave name.	See the separate “Appendix”.
Pitch (V)	Pitch. Adjusts the maximum and minimum pitch values within a range of $\pm 2$ octaves. A setting of $-256$ lowers the pitch two octaves, while a setting of $255$ raises the pitch two octaves.	$-256$ to 0 to $+255$
Detune (V)	Detune. Fine adjustment of the tuning.	$-256$ to 0 to $+255$
KeyFollow (V)	Key follow. Adjusts the amount of pitch change between neighboring keyboard keys. A higher value represents greater change. Example: When Key Follow Base is keyboard key C4 	$-128$ to 0 to $+127$

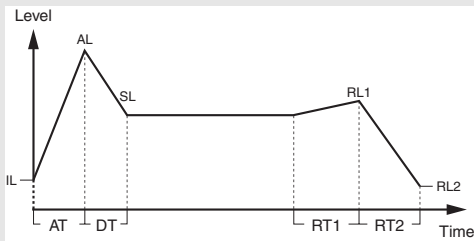
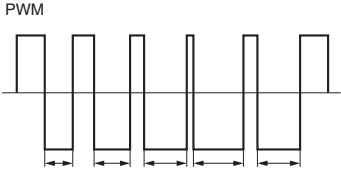
Display Text	Description	Settings
KeyFolBase (V)	Key follow base. Keyboard key that is the center of key follow. • Setting value can be specified using the keyboard keys.	C- to G9*
Env.Depth (V)	Envelope depth. Specifies how the envelope shown below is applied.	-64 to 0 to +63
Envelope >Ent	<p>Pitch envelope. Group of editable parameters for envelope (Envelope Generator) applied to the synth OSC, PCM OSC, and pitch shifter.</p> <ul style="list-style-type: none"> <li>The figure below also applies to filter, amp, and other envelopes. With the pitch envelope, the pitch of the sound corresponds to the vertical (Level) axis.</li> </ul>  <p>IL : Init Level                      RT1 : Release Time1  AT : Attack Time                    RL1 : Release Level1  AL : Attack Level                   RT2 : Release Time2  DT : Decay Time                    RL2 : Release Level2  SL : Sustain Level</p>	
Init.Level (V)	Initial level. Pitch of the sound at initial note on.	-64 to 0 to +63
Atk.Time (V)	Attack time. Time it takes until the attack level is reached from the initial level.	0 to 127
Atk.Level (V)	Attack level. Target level reached immediately after note on.	-64 to 0 to +63
Dcy.Time (V)	Decay time. Time it takes for the sound to reach the sustain level from the attack level.	0 to 127
Sus.Level (V)	Sustain level. Level the sound is sustained as long as a key or pedal is depressed.	-64 to 0 to +63
Rel.Time1 (V)	Release time 1. Time it takes to reach Release Level 1 after a key is released.	0 to 127
Rel.Level1 (V)	Release level 1. Target level reached immediately after a key is released.	-64 to 0 to +63
Rel.Time2 (V)	Release time 2. Time it takes to reach Release Level 2 from Release Level 1.	0 to 127
Rel.Level2 (V)	Release level 2. Second target level reached after a key is released.	-64 to 0 to +63
Clk.Trig	Clock trigger. Specifies the number of beats for resetting the envelope. Selecting a setting from 1/4U to 4U resets to the timing of the up beat.	Off, 1/4, 1/3, 1/2, 2/3, 1, 3/2, 2, 3, 4, 1/4U, 1/3U, 1/2U, 2/3U, 1U, 3/2U, 2U, 3U, 4U
Ext.Trig (Block (5) only)	External trigger. When on, the envelope is reset by an external trigger.	Off, On
LFO1 Depth (V)	LFO1 depth. Specifies how LFO1 from Block (8) is applied.	-64 to 0 to +63
LFO2 Depth (V)	LFO2 depth. Specifies how LFO2 from Block (9) is applied.	-64 to 0 to +63
PulseWidth (Blocks (1) and (2) only) (V)	Pulse width. Adjusts the width of the square wave when the synth wave is a square wave.	0 to 127
PWM LFO1 Dep (Blocks (1) and (2) only) (V)	<p>PWM LFO1 depth. Adjusts the depth of pulse width modulation by LFO1.</p> 	-64 to 0 to +63
PWM LFO2 Dep (Blocks (1) and (2) only) (V)	PWM LFO2 depth. Adjusts the depth of pulse width modulation by LFO2.	-64 to 0 to +63
Sync OSC (Block (2) only)	Oscillator sync. Turning on this resets the Block (2) sound wave in accordance with the Block (1) sound wave period, cause them to become synced.	Off, On

Display Text	Description	Settings
OriginalKey (Block (5) only)(V)	Original key. Selects the keyboard keys where the externally input sound to Block (5) is sounded as-is at its original pitch. • Setting can be specified using the keyboard keys.	C- to G9*
MicInstLvl (Block (5) only) (V)	Mic/inst level. Level of external input sound to Block (5).	0 to 127
TrigThresh (Block (5) only) (V)	Trigger threshold. Specifies the external input level threshold value that determines whether or not an external input trigger (page E-24) is applied.	0 to 127
TrigRelease (Block (5) only) (V)	Trigger release time. Adjusts the time following external input trigger (page E-24) operation that the next trigger operation is blocked.	0 to 127
P.ShiftMode (Block (5) only)	Pitch shifter mode. A larger setting value lengthens the time until note on, but increases tone quality. When this setting is off, the same pitch sounds no matter which keyboard key is pressed.	Off, 1, 2, 3
P.ShiftMix (Block (5) only)	Pitch shifter mix. Specifies the volume ratio between the pitch shifted sound (shift sound) and the unshifted sound. 0: Shift sound only 7: Both sounds at same volume 15: Original sound only	0 to 15
Noise Type (Block (6) only)	Noise type. Selects the type of noise generated by Block (6). White noise (equal noise for all frequencies), pink noise (noise inversely proportional to the frequency) and other types of noise are available. • See the separate "Appendix" for a complete list of noise types.	See the separate "Appendix".
Filter >Ent	Filter. Group of editable parameters associated with the filters (tones) in each block.	
Gain	Gain. Specifies how the volume of frequency components that are higher than the cut off frequency setting value described below is attenuated. There is no cut off when "Flat" is specified here.	-18dB, -12dB, -6dB, -3dB, Flat
Cutoff (V)	Cutoff frequency. Specifies the filter cutoff frequency.	0 to 15
TouchSense (V)	Touch sense. Specifies the degree of change in the filter in accordance with change in keyboard playing touch.	-64 to 0 to +63
KeyFollow (V)	Key follow. Adjusts the amount of filter change between neighboring keyboard keys. A higher value represents greater change.	-128 to 0 to +127
KeyFolBase (V)	Key follow base. Keyboard key that is the center of key follow. • Setting can be specified using the keyboard keys.	C- to G9*
Env.Depth (V)	Envelope depth. Specifies how the envelope shown below is applied.	-64 to 0 to +63
Envelope >Ent	Filter envelope. Group of editable parameters for envelope (Envelope Generator) applied to filters. • For details about group items and setting ranges, see "Pitch Envelope". With this group, the vertical (Level) axis in the pitch envelope diagram corresponds to how the filter is applied.	0 to 127 (Initial Level to Release Level 2) • The setting ranges for Clock Trigger and External Input Trigger are the same as those for Pitch Envelope.
LFO1 Depth (V)	LFO1 depth. Specifies how LFO1 from Block (8) is applied.	-64 to 0 to +63
LFO2 Depth (V)	LFO2 depth. Specifies how LFO2 from Block (9) is applied.	-64 to 0 to +63
Amp >Ent	Amp. Group of editable parameters associated with the amp (volume) in each block.	
Volume (V)	Volume. Specifies the amp volume.	0 to 127
TouchSense (V)	Touch sense. Specifies the degree of change in volume in accordance with change in keyboard playing touch.	-64 to 0 to +63
KeyFollow (V)	Key follow. Adjusts the amount of volume change between neighboring keyboard keys. A higher value represents greater change.	-128 to 0 to +127
KeyFolBase (V)	Key follow base. Keyboard key that is the center of key follow. • Setting can be specified using the keyboard keys.	C- to G9*
Envelope >Ent	Amp envelope. Group of editable parameters for envelope (Envelope Generator) applied to amps. • For details about group items, see "Pitch Envelope". The vertical (Level) axis in the pitch envelope diagram corresponds to the volume in the case of this group. However, the setting range for the nine items from Initial Level to Release Level 2 is 0 to 127, which is different from the pitch envelope items.	0 to 127 (Initial Level to Release Level 2) • The setting ranges for Clock Trigger and External Input Trigger are the same as those for Pitch Envelope.
LFO1 Depth (V)	LFO1 depth. Specifies how LFO1 from Block (8) is applied.	-64 to 0 to +63
LFO2 Depth (V)	LFO2 depth. Specifies how LFO2 from Block (9) is applied.	-64 to 0 to +63

 **Selecting and Creating Tones**

Display Text	Description	Settings
Legato	Legato. Turning this setting on causes subsequent notes to be played smoothly and connected.	Off, On
Portamento	Portamento. Turning on this setting applies a portamento effect. <ul style="list-style-type: none"><li>• This item is not present in Block (6).</li></ul>	Off, On
PortaTime (V)	Portamento Time. Specifies the time until the next note is reached by Portamento. <ul style="list-style-type: none"><li>• This item is not present in Block (6).</li></ul>	0 to 127

\* "C-" on the display indicates C-1 (one octave below C0).

## ■ Block (7): Total Block Filter Editable Parameters

### Preparation

On the screen that appears in step 2 under “To edit and save a tone as a user tone” (page E-20), select “Total Filter >Ent” and then press **17** ENTER to enter the group.

### Editable Parameter List

- Shaded cells indicate a group made up of multiple items. Press **17** ENTER to display the items that make up a group.
- (V) at the end of a display item indicates an item that can be selected as a Block (10) virtual controller destination (page E-29).

Display Text	Description	Settings
FilterType	Filter type. Selects the filter type. LPF: Low-pass filter. Cuts high-range components above the cut off frequency. BPF: Band-pass filter. Cuts low-range and high-range components outside of a range centered on the cut off frequency. HPF: High-pass filter. Cuts low-range components below the cut off frequency.	Refer to the cell to the left.
Cutoff (V)	Cutoff frequency. Specifies the cut off frequency of all Solo Synthesizer tones.	0 to 127
Resonance (V)	Resonance. Emphasizes notes in the vicinity of the cut off frequency to alter the tone.	0 to 127
TouchSense (V)	Touch sense. Specifies the degree of change in the filter in accordance with change in keyboard playing touch.	-64 to 0 to +63
KeyFollow (V)	Key follow. Adjusts the amount of filter change between neighboring keyboard keys. A higher value represents greater change.	-128 to 0 to +127
KeyFolBase (V)	Key follow base. Keyboard key that is the center of key follow. • Setting can be specified using the keyboard keys.	C- to G9*
Env.Re trig	Envelope generator retrigger. Turning on this setting retriggers the filter with each keyboard key press.	Off, On
Env.Depth (V)	Envelope depth. Specifies how the envelope shown below is applied.	-64 to 0 to +63
Envelope >Ent	Total filter envelope. Group of editable parameters for envelope (Envelope Generator) applied to Total Block filters. • For details about group items, see “Pitch Envelope”. With this group, the vertical (Level) axis in the pitch envelope diagram corresponds to how the filter is applied.	0 to 127 (Initial Level to Release Level 2) • The setting ranges for Clock Trigger and External Input Trigger are the same as those for Pitch Envelope.
LFO1 Depth (V)	LFO1 depth. Specifies how LFO1 from Block (8) is applied.	-64 to 0 to +63
LFO2 Depth (V)	LFO2 depth. Specifies how LFO2 from Block (9) is applied.	-64 to 0 to +63

\* “C-” on the display indicates C-1 (one octave below C0).

**■ Block (8): LFO1 and Block (9): LFO2 Editable Parameters**

**Preparation**

























Perform the following steps from the screen in step 2 of the procedure under “To edit and save a tone as a user tone” on page E-20.

**1. Select “LFO >Ent” and then press  ENTER to enter the group.**

**2. Use the  PART minus (-) and plus (+) buttons to select the block you want to edit.**

**Editable Parameter List**

• (V) at the end of a display item indicates an item that can be selected as a Block (10) virtual controller destination (page E-29).

Display Text	Description	Settings																
WaveType	<p>Wave type. Specifies one of the following wave types to be used for LFO.</p> <table border="0"> <tr> <td>Sin (Sine Wave)</td> <td></td> <td>Puls 1:3 (Square Wave 1:3)</td> <td></td> </tr> <tr> <td>Tri (Triangular Wave)</td> <td></td> <td>Puls 2:2 (Square Wave 2:2)</td> <td></td> </tr> <tr> <td>Saw up (Sawtooth Wave Up)</td> <td></td> <td>Puls 3:1 (Square Wave 3:1)</td> <td></td> </tr> <tr> <td>Saw down (Sawtooth Wave Down)</td> <td></td> <td>Random (Random)</td> <td></td> </tr> </table>	Sin (Sine Wave)		Puls 1:3 (Square Wave 1:3)		Tri (Triangular Wave)		Puls 2:2 (Square Wave 2:2)		Saw up (Sawtooth Wave Up)		Puls 3:1 (Square Wave 3:1)		Saw down (Sawtooth Wave Down)		Random (Random)		Refer to the cell to the left.
Sin (Sine Wave)		Puls 1:3 (Square Wave 1:3)																
Tri (Triangular Wave)		Puls 2:2 (Square Wave 2:2)																
Saw up (Sawtooth Wave Up)		Puls 3:1 (Square Wave 3:1)																
Saw down (Sawtooth Wave Down)		Random (Random)																
Sync	<p>Sync. Specifies what LFO is synced with.</p> <p>Off: No syncing</p> <p>Tempo: Synced with beat specified by clock sync (see below).</p> <p>LFO1 (Can be selected with LFO2 only.): Synced with LFO1.</p>	Refer to the cell to the left.																
Rate (V)	Rate. Specifies the LFO speed (frequency). This setting is enabled when the above Sync setting is off.	0 to 127																
Clk.Sync	<p>Clock sync. Specifies the number of beats synced with the LFO frequency. Selecting a setting from 1/4U to 4U syncs with the timing of the up beat.</p> <p>• This setting a valid only when the sync setting is “Tempo”.</p>	1/4, 1/3, 1/2, 2/3, 1, 3/2, 2, 3, 4, 1/4U, 1/3U, 1/2U, 2/3U, 1U, 3/2U, 2U, 3U, 4U																
Depth (V)	Depth. Specifies how LFO is applied.	0 to 127																
Delay (V)	Delay. Specifies the degree of delay in the timing for applying LFO.	0 to 127																
Rise (V)	Rise. Specifies the time it takes from the start of application of the LFO until the effect reaches the level specified by Depth above.	0 to 127																
Mod.Depth (V)	Modulation depth. Specifies how modulation is applied to the LFO.	0 to 127																

### ■ Block (10): Controllers Editable Parameters for Virtual Controller

These controllers are virtual controllers for adjusting any editable parameters (destinations) with any input method (source).

#### Preparation

Perform the following steps from the screen in step 2 of the procedure under “To edit and save a tone as a user tone” on page E-20.

#### 1. Select “VirtualCtrl >Ent” and then press **17** ENTER to enter the group.

- Controllers are numbered 1 through 8, and are assigned to the **5** sliders (1/9 through 8/16).

#### 2. Use the **9** PART minus (–) and plus (+) buttons to select the number of the controller you want to edit.

#### Editable Parameter List

Display Text	Description	Settings
Source	Source. Specifies the input method. Off: None CC00 to CC97: MIDI control change* NoteOnKeyNum: Key number of MIDI note on message NoteOnVel: Velocity value of MIDI note on message Ch.Pressure: MIDI channel after touch Bend Up: Upward operation from <b>19</b> BENDER center Bend Down: Downward operation from <b>19</b> BENDER center Modulation: <b>19</b> MODULATION operation LFO1: LFO1 (Block (8)) LFO2: LFO2 (Block (9))  * For details about each setting, refer to the MIDI Implementation document ( <a href="http://world.casio.com/">http://world.casio.com/</a> ) and other MIDI documentation.	Refer to the cell to the left.
Depth	Depth. Specifies how virtual controller is applied.	–128 to 0 to +127
Dest	Destination. Specifies the destination parameter for a virtual controller operation.	<ul style="list-style-type: none"> <li>• Off</li> <li>• Block (1) to (9) parameters (pages E-23 through E-28) whose “Display Text” items have “(V)” after them.</li> <li>• DSP parameters (page E-100)</li> </ul>

### ■ Other Editable Items

This section explains parameters that are not part of the blocks described up to this point. These settings not only apply to the Solo Synthesizer, but also to other category tones as well.

#### Preparation

Display the screen in step 2 of the procedure under “To edit and save a tone as a user tone” on page E-20.

#### Editable Parameter List

- Shaded cells indicate a group made up of multiple items. Press **17** ENTER to display the items that make up a group.

Display Text	Description	Settings
DSP On/Off (Non-Solo Synthesizer tones only)	DSP on/off. Specifies whether or not DSP should be applied to tones. • When this setting is on, pressing <b>17</b> ENTER enters the DSP editing screen (page E-39). • This item is not displayed on the Solo Synthesizer tone editing list.	Off, On
DSP Edit >Ent	DSP edit. Group of editable effect function DSPs (page E-36). Press <b>17</b> ENTER to advance to the DSP editing screen. Disabled when the above DSP On/Off setting is off.	
Volume	Volume. Specifies the main volume.	0 to 127
Rev.Send	Reverb send. Specifies how reverb (page E-36) is applied to a tone.	0 to 127
Cho.Send (Non-Solo Synthesizer tones only)	Chorus send. Specifies how chorus (page E-36) is applied to a tone. • This item is not displayed on the Solo Synthesizer tone editing list.	0 to 127

## **Editable Parameters for PCM Melody Tone (Non-drum PCM Tones)**

There are two types of parameters: PCM melody tone specific editable parameters and the same parameters that apply to the other tone categories.

The drum sets in the PCM tones have different editable parameters. See “Editable Parameters for Drum PCM Tone” for more information about them.

### **■ Editable Parameters for Non-drum Set PCM Tone**

#### **Preparation**

Display the screen in step 2 of the procedure under “To edit and save a tone as a user tone” on page E-20.

#### **Editable Parameter List**

<b>Display Text</b>	<b>Description</b>	<b>Settings</b>
Atk.Time	Attack time. Specifies the time it takes to reach peak value from note on.	-64 to 0 to +63
Rel.Time	Release time. Specifies the time it takes for a sustained sound to decay after a key is released.	-64 to 0 to +63
Cutoff	Cutoff frequency. Specifies the tone cutoff frequency.	-64 to 0 to +63
Vib.Type	Vibrato type. Specifies one of the wave types below to be used for vibrato. Sin (sine wave), Tri (triangular wave), Saw (sawtooth wave), Sqr (square wave)	Sin, Tri, Saw, Sqr
Vib.Depth	Vibrato depth. Specifies how vibrato is applied.	-64 to 0 to +63
Vib.Rate	Vibrato rate. Specifies the vibrato rate (frequency).	-64 to 0 to +63
Vib.Delay	Vibrato delay. Specifies the delay in the timing for applying vibrato.	-64 to 0 to +63
Oct.Shift	Octave shift. Changes the tone of notes in octave units.	-2 to 0 to +2
TouchSense	Touch sense. Specifies the degree of change in volume in accordance with change in keyboard playing touch.	-64 to 0 to +63

### **■ Editable Parameters Common to Other Tone Categories**

See “Other Editable Items” on page E-29.



## Editable Parameters for Drum PCM Tone

The editable parameters described here are for the drum set tones. There are two types of parameters: PCM drum tone specific editable parameters and the same parameters that apply to the other tone categories.

### ■ Editable Parameters for Drum Set PCM Tone

#### Preparation

Display the screen in step 2 of the procedure under “To edit and save a tone as a user tone” on page E-20.

#### Editable Parameter List

- Shaded cells indicate a group made up of multiple items. Press **17** **ENTER** to display the items that make up a group.

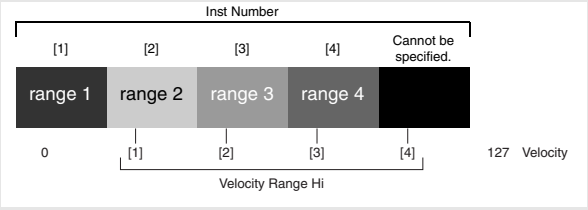
Display Text	Description	Settings
Inst Edit >Ent	Instrument edit. Group of editable parameters for drum tone for each keyboard. <ul style="list-style-type: none"> <li>• Press a keyboard key to specify the keyboard to be edited.</li> <li>• This group can be entered by performing step 1 under “To edit and save a tone as a user tone” (page E-20) and then holding down <b>7</b> <b>EDIT</b>.</li> </ul>	(C- to G9*)
Inst Select >Ent	Instrument select. Group of editable parameters for tone. Keyboard key pressure (Velocity) is divided into four velocity ranges. Each range can be configured to sound a different tone (Inst Number). <ul style="list-style-type: none"> <li>• Use the <b>9</b> <b>PART minus (-) and plus (+) buttons</b> to select the range you want to edit.</li> </ul> 	
Inst Number	Instrument number. Selects the drum tone wave assigned to each velocity range. <ul style="list-style-type: none"> <li>• See the separate “Appendix” for details about wave types.</li> <li>• The splits of a user wave tone (User Wave) can be assigned as Inst Numbers. User wave names consist of the text “UserWave”, followed by two number separated by a hyphen (such as: UserWave 1-2). The number to the left of the hyphen (1 in the example), is a user number from 1 to 10 or the letter R (sample looper recorded data). The number to the right of the hyphen (2 in the example) a split number from 1 to 5. If the data includes a wave, an asterisk (*) is appended to the beginning of the user wave name.</li> </ul>	See the separate “Appendix”.
VelRangeHi	Velocity range high. Determines the high limit of each velocity range.	0 to 127
Volume	Volume. Specifies drum sound volume.	-128 to 0 to +127
Pan	Pan. Specifies the stereo position of drum sound.	-64 to 0 to +63
Rev.Send	Reverb send. Specifies how reverb is applied to a drum tone.	0 to 127
NoteOffMode	Note off mode. Turning on this setting causes note off to be performed when a key is released.	Off, On
Assign Grp	Assign group. Specifies as a value from 1 to 15 which group the currently selected keyboard should be placed into. Only one keyboard in a group is sounded at any time (non-polyphonic).	Off, 1 to 15
Pitch LFO >Ent	Pitch LFO. Group of editable LFOs applied to pitch.	
WaveType	Wave type. Specifies a wave type to be used for LFO. The details of the selectable waves are the same as those for “WaveType” of “Block (8): LFO1 and Block (9): LFO2 Editable Parameters” (page E-28).	Sin, Tri, SawUp, SawDown, Puls1:3, Puls2:2, Puls3:1
Rate	Rate. Specifies the LFO speed (frequency).	0 to 127
Depth	Depth. Specifies how LFO is applied.	-128 to 0 to +127
Delay	Delay. Specifies the degree of delay in the timing for applying LFO.	0 to 127
Rise	Rise. Specifies the time it takes from the start of application of the LFO until the effect reaches the level specified by Depth above.	0 to 127
Mod.Depth	Modulation depth. Specifies how modulation is applied to the LFO.	0 to 127
After Depth	After depth. Specifies LFO change when MIDI channel after touch is received.	0 to 127

Display Text	Description	Settings
Amp LFO >Ent	Amp LFO. Group of editable LFOs applied to volume. Items within a group and setting ranges are the same as “LFO (Pitch LFO)”, above.	Refer to the cell to the left.

\* “C-” on the display indicates C-1 (one octave below C0).

### ■ Editable Parameters Common to Other Tone Categories

For information about Solo Synthesizer tones, see “Other Editable Items” on page E-29.

### ■ Editable Parameters for User Wave Tone

There are two types of editable parameters for user wave tone: editable parameters that are specific to the User Wave Tone category and the parameters that also apply to the other tone categories.

### ■ User Wave Tone Category Specific Tone Parameters

#### Preparation

Display the screen in step 2 of the procedure under “To edit and save a tone as a user tone” on page E-20.

#### Editable Parameter List

• Shaded cells indicate a group made up of multiple items. Press **17** ENTER to display the items that make up a group.

Display Text	Description	Parameter
Split Edit >Ent	Split Edit. Group of editable parameters for splits recorded with the sample looper. • Use the <b>9</b> PART minus (-) and plus (+) buttons to switch between splits.	
Volume	Volume. Specifies the volume.	0 to 127
Pan	Pan. Specifies the stereo position of the sound.	-64 to 0 to 63
CoarseTune	Coarse tune. Changes the pitch of notes by semitone units.	-24 to 0 to 24
Fine Tune	Fine tune. Fine tunes the pitch of the sound. Lowers the value up to -256 or raises the value up to +255 in semitone steps.	-256 to 0 to 255
CutOff	Cutoff frequency. Specifies the cut off frequency of a user wave tone.	0 to 127
TouchSense	Touch sense. Specifies the degree of change in volume in accordance with change in keyboard playing touch.	-64 to 0 to 63
KeyFollow	Key follow. Adjusts the amount of pitch change between neighboring keyboard keys. A higher value represents greater change.	-128 to 0 to 127
KeyFolBase	Key follow base. Keyboard key that is the center of key follow. • Setting can be specified using the keyboard keys.	C- to G9*
P.Env.Depth	Pitch envelope depth. Specifies how envelopes are applied to pitch.	-64 to 0 to 63
Pitch Env >Ent	Pitch envelope. Group of editable parameters for envelope (Envelope Generator) applied to pitch.	
Init.Level	Initial level. Pitch of the sound at initial note on.	-64 to 0 to 63
Atk.Time	Attack time. Time it takes until Level 0 is reached from the initial level.	0 to 127
Rel.Time	Release time. Time it takes to reach Release Level after a key is released.	0 to 127
Rel.Level	Release Level. Target level reached immediately after a key is released.	-64 to 0 to 63
Amp Env >Ent	Amp envelope. Group of editable parameters for envelope (Envelope Generator) applied to amps. • For details about group items, see “Pitch Envelope” (page E-24). The vertical (Level) axis in the pitch envelope diagram corresponds to the volume in the case of this group. However, the setting range for the nine items from Initial Level to Release Level 2 is 0 to 127, which is different from the pitch envelope items. Note, however, that there is no Clock Trigger item on the user tone “Amp Env >Ent” menu.	0 to 127 (Initial Level to Release Level 2) • The External Input Trigger range is the same as those for “Pitch Envelope”.
KeyRangeLow	Key Range Low. Sets the low range of the effective keyboard for split playback. • Setting can be specified using the keyboard keys.	C- to G9*
KeyRangeHi	Key Range High. Sets the high range of the effective keyboard for split playback. • Setting can be specified using the keyboard keys.	C- to G9*
OriginalKey	Original key. Specifies the keyboard where the split plays as-is. • Setting can be specified using the keyboard keys.	C- to G9*
Points >Ent	Point. Changes the split start point, loop point, and end point positions.	

Display Text	Description	Parameter
Start	<p>Start Point. The overall length of a split is recorded as values as shown in the illustration below. You can change the start point of a split by changing its first number.</p> <ul style="list-style-type: none"> <li>You can input the split start point value using the <b>16 number buttons (0 to 9)</b>.</li> <li>You can also use the <b>17 minus (-) and plus (+) buttons</b> to change the leftmost three digits of the value.</li> </ul> <p>Example: Changing the first position number from 100000 to 125000 will move the start point to a position later in the loop.</p>	<p>0 to 205000 (stereo recording), 0 to 410000 (monaural recording)</p>
Loop	<p>Loop Point. As with the Start Point, you can change the position of the loop point.</p> <ul style="list-style-type: none"> <li>You can input the split loop point value using the <b>16 number buttons (0 to 9)</b>.</li> <li>You can also use the <b>17 minus (-) and plus (+) buttons</b> to change the leftmost three digits of the value.</li> </ul>	<p>0 to 205000 (stereo recording), 0 to 410000 (monaural recording)</p>
End	<p>End Point. As with the Start Point, you can change the position of the end point.</p> <ul style="list-style-type: none"> <li>You can input the split end point value using the <b>16 number buttons (0 to 9)</b>.</li> <li>You can also use the <b>17 minus (-) and plus (+) buttons</b> to change the leftmost three digits of the value.</li> </ul>	<p>0 to 205000 (stereo recording), 0 to 410000 (monaural recording)</p>
Pitch LFO >Ent	<p>Pitch LFO. This is a group of editable parameters for LFOs applied to pitch. The settings ranges of the parameters in this group are the same as for Pitch LFO of the "Editable Parameters for Drum Set PCM Tone" (page E-31).</p>	<p>Refer to the cell to the left.</p>
Amp LFO >Ent	<p>Amp LFO. This is a group of editable parameters for LFOs applied to volume. The settings ranges of the parameters in this group are the same as for Amp LFO of the "Editable Parameters for Drum Set PCM Tone" (page E-31).</p>	<p>Refer to the cell to the left.</p>

\* "C-" on the display indicates C-1 (one octave below C0).

### ■ Editable Parameters Common to Other Tone Categories

For information about Solo Synthesizer tones, see "Other Editable Items" on page E-29.

## Controlling Sounds

You can use a pedal, the bender, or other devices, to instantly change the pitch and volume of notes, the envelope, and other parameters as you perform.

### Using a Pedal

A pedal operation can be used to sustain notes, arpeggios (page E-40), or phrases (page E-45), or to apply a soft effect.

- For information about connecting a pedal, see page E-8.
- You can specify the effect applied by a pedal operation by performing the following operation on the performance editing list: Controller >Ent → Pedal. See page E-74 for more information.

### Using the Wheels (Bender, Modulation)

The **19 BENDER** wheel can be used to seamlessly raise or lower the pitch of a sound, while the **19 MODULATION** wheel adds vibrato (modulation effect) to the sound.

**19**

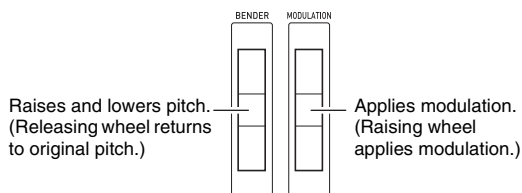

- Do not have a wheel rotated as you turn on Synthesizer power.
- You can control the bend range of the **19 BENDER** wheel by configuring the following settings on the performance editing list: BendRngDwn, BendRngUp (page E-73).

### Using the Assignable Knobs

The four **3 ASSIGNABLE KNOBS** can be assigned functions that enable instant adjustment of a sound attack time and other envelope parameters (page E-21), volume, and more.

**3**

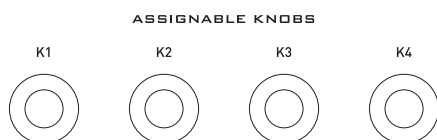

- The following shows the knob functions for each Zone Part 1 tone category.

Solo Synthesizer tones (page E-23)

- K1 : Virtual Controller 1 (page E-29)
- K2 : Virtual Controller 2 (page E-29)
- K3 : Virtual Controller 3 (page E-29)
- K4 : Virtual Controller 4 (page E-29)

PCM melody tones (page E-30)

- K1 : Cut off Frequency
- K2 : Attack Time
- K3 : Release Time
- K4 : Reverb Send (Same as other tone categories.)

PCM drum tones (page E-31)

- K1 : Volume (Drum Inst >)
- K2 : Pan (Drum Inst >)
- K3 : Reverb Send (Drum Inst >)
- K4 : Reverb Send (Same as other tone categories.)

User Wave tones (page E-32)

- K1 : Cut off Frequency
- K2 : Attack Time (Amp Envelope >)
- K3 : Release Time (Amp Envelope >)
- K4 : Reverb Send (Same as other tone categories.)

The above functions show the abbreviated names used on the tone mode screen.



- In the performance mode, you can change the operations currently assigned to the assignable knobs by performing the following operation on the performance editing list (page E-74): Controller >Ent → K1 to K4.

### Using Sliders

You can use the **nine sliders (5)** to make simple adjustments to the Solo Synthesizer oscillator, envelope, and total filter/LFO parameters.

1. Select a Solo Synthesizer tone.
2. Use the **1** buttons to assign oscillator (OSC BLOCK), envelope (ENV GENERATOR) or total filter/LFO (TOTAL FILTER/LFO) parameters to the sliders.
  3. Use the three **2** buttons to perform one of the operations described below.
    - If you selected OSC BLOCK (oscillator) in step 2
      - Press **2 SELECT OSC** to cycle through the OSC blocks (1 through 6) and "ALL" (all OSC blocks), and select the one you want.
    - If you selected ENV GENERATOR (envelope) in step 2
      - Press **2 SELECT OSC** to cycle through the OSC blocks (1 through 6) and "ALL" (all OSC blocks), and select the one you want.
      - Press **2 SELECT EG** to cycle through the EG blocks (OSC, Filter, Amp, "ALL" (all EG blocks)) and select the one you want.
    - If you selected TOTAL FILTER/LFO (total filter/LFO) in step 2
      - Press **2 SELECT LFO** to toggle between LFO1, LFO2, and "ALL" (LFO1 and LFO2).

#### 4. Move the sliders (5) to adjust the parameters currently assigned to them.

- Refer to the table below for information about the parameters assigned to the sliders. For detailed information about each parameter, see the reference pages included in the table.

1 button	5 (Slider)	Display Text	Parameter	See page:
<b>OSC BLOCK</b>				
	1/9	OSC ON/OFF	OSC Block > OSC On/Off	E-23
	2/10	WAVE	OSC Block > Oscillator > Wave (Disabled for Ext OSC.) • See the separate "Appendix" for the types of waves that can be selected using the sliders.	E-23
	3/11	PITCH	OSC Block > Oscillator > Pitch (Disabled for Noise OSC.)	E-23
	4/12	DETUNE	OSC Block > Oscillator > Detune (Disabled for Noise OSC.)	E-23
	5/13	PORTA TIME	OSC Block > PortaTime	E-26
	6/14	P.ENV DEPTH	OSC Block > Oscillator > Env.Depth (Disabled for Noise OSC.)	E-24
	7/15	CUTOFF	OSC Block > Filter > CutOff	E-25
	8/16	F.ENV DEPTH	OSC Block > Filter > Env.Depth	E-25
	MASTER	VOLUME	OSC Block > Amp > Volume	E-25
<b>ENV GENERATOR</b>				
	1/9	INIT LEVEL	• OSC Block > Oscillator/Filter/Amp > Envelope > Init.Level • TotalFilter > Envelope > Init.Level	E-24
	2/10	ATK TIME	• OSC Block > Oscillator/Filter/Amp > Envelope > Atk.Time • TotalFilter > Envelope > Atk.Time	E-24
	3/11	ATK LEVEL	• OSC Block > Oscillator/Filter/Amp > Envelope > Atk.Level • TotalFilter > Envelope > Atk.Level	E-24
	4/12	DCY TIME	• OSC Block > Oscillator/Filter/Amp > Envelope > Dcy.Time • TotalFilter > Envelope > Dcy.Time	E-24
	5/13	SUS LEVEL	• OSC Block > Oscillator/Filter/Amp > Envelope > Sus.Level • TotalFilter > Envelope > Sus.Level	E-24
	6/14	REL TIME1	• OSC Block > Oscillator/Filter/Amp > Envelope > Rel.Time1 • TotalFilter > Envelope > Rel.Time1	E-24
	7/15	REL LEVEL1	• OSC Block > Oscillator/Filter/Amp > Envelope > Rel.Level1 • TotalFilter > Envelope > Rel.Level1	E-24
	8/16	REL TIME2	• OSC Block > Oscillator/Filter/Amp > Envelope > Rel.Time2 • TotalFilter > Envelope > Rel.Time2	E-24
	MASTER	REL LEVEL2	• OSC Block > Oscillator/Filter/Amp > Envelope > Rel.Level2 • TotalFilter > Envelope > Rel.Level2	E-24
<b>TOTAL FILTER/LFO</b>				
	1/9	TOTAL FILTER TYPE	TotalFilter > FilterType	E-27
	2/10	TOTAL FILTER CUTOFF	TotalFilter > CutOff	E-27
	3/11	TOTAL FILTER RESONANCE	TotalFilter > Resonance	E-27
	4/12	TOTAL FILTER ENV.DEPTH	TotalFilter > Env.Depth	E-27
	5/13	LFO WAVE	LFO > WaveType	E-28
	6/14	LFO RATE	LFO > Rate (Enabled only for Sync Off.)	E-28
	7/15	LFO DEPTH	LFO > Depth	E-28
	8/16	LFO DELAY	LFO > Delay	E-28
	MASTER	LFO RISE	LFO > Rise	E-28

#### NOTE

- In the Performance Mode or Step Sequencer Mode, you can use the 1 buttons to edit tones with the sliders without changing to another mode.
- PCM tones and user wave tones cannot be adjusted using the sliders.
- For more information about slider functions, see page E-52 for the Step Sequencer Mode and page E-78 for the Mixer Mode.

### Using the Hold Button

When the **13 HOLD** button is lit (by pressing it), the currently sounding note or arpeggio (page E-40) will be sustained.

- 13** Lights when HOLD is on.

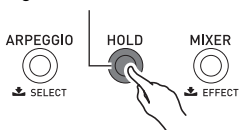

- Pressing **13 HOLD** again will cause its light to go out, indicating that hold is turned off.

### Changing the Pitch of Notes in Semitone Steps (Transpose) or Octave Steps (Octave Shift)

You can use the **18 TRANSPOSE** and **OCTAVE (-, +)** buttons to change the pitch of the keyboard notes in semitone or octave steps.

- For information about fine tuning the pitch in hertz steps (Tuning), see page E-81.

#### 1. To change the pitch in semitone steps, hold down **18 TRANSPOSE** as you press the **18 OCTAVE** minus (-) or plus (+) button.

- The setting range for this operation is one octave upwards and downwards (-12 semitones to +12 semitones).

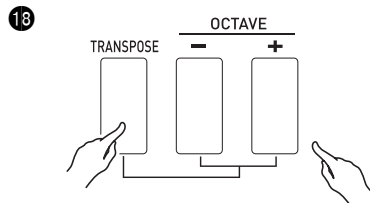

#### 2. To change the pitch in octave steps, use the **18 OCTAVE** minus (-) and plus (+) buttons (without holding down **18 TRANSPOSE**).

- The setting range for this operation is three octaves upwards and downwards (-3 octaves to +3 octaves).

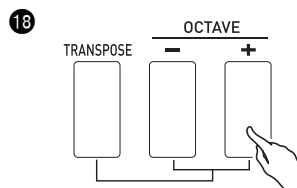

#### NOTE

- While the setting screen shown above is displayed you can the **15 dial** or the **17 minus (-) or plus (+) buttons** to change the setting. If you do not perform any operation for a while, the setting screen will be exited automatically.

### Applying Effects to Notes

You can apply reverb, vibrato, and other effects to notes to enhance their sound.

#### ■ Effect Block Diagram

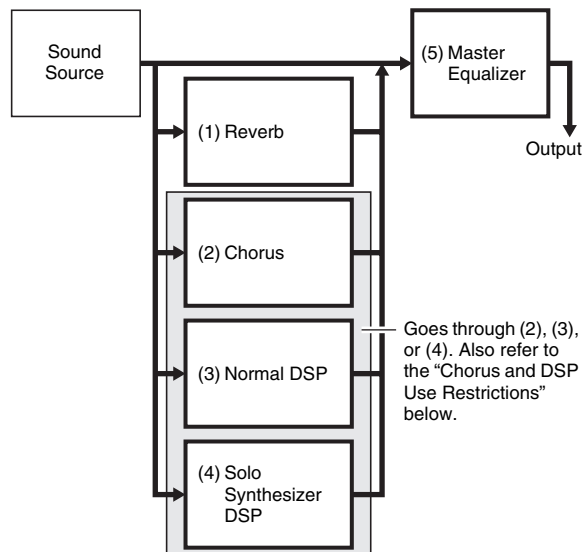

(1) Reverb	Adds reverberation to make it sound like you are playing in a room or in a hall.
(2) Chorus	Combines multiple layers of the same note to create a sound with more depth.
(3) Normal DSP	A collection of versatile Normal DSP effects help to enhance the sound of tones. For example, distortion can be applied to an electric guitar sound to make it sound more powerful. There are 46 different Normal DSP types, and the most appropriate one for the selected tone is applied automatically.* A DSP can be edited and saved as a user DSP.
(4) Solo Synthesizer DSP	One of the elements that makes up a Solo Synthesizer tones. See “(7) Total Block” in the “Editable Parameters for Solo Synthesizer Tone” on page E-21. There are six Solo Synthesizer DSP types. When you edit a Solo Synthesizer DSP, it is saved as part of a Solo Synthesizer user tone. You cannot save it as a user DSP.
(5) Master Equalizer	Adjusts the frequency characteristics of the Synthesizer’s notes. The Master Equalizer can be used to adjust the frequency and gain of four frequency bands: low, mid1, mid2, and high.

\* When a tone with DSP (tone that uses a particular DSP) that is not a Solo Synthesizer tone is selected. A tone with DSP will have “DSP” next to its display name on the mixer screen (page E-78) or performance editing screen (page E-73).

### ■ Chorus and DSP Use Restrictions

Only one of the three effect types (Chorus, Normal DSP, Solo Synthesizer DSP) can be enabled at any time.

Under this condition:	This type of effect is valid:	And effects are applied to each part like this:
<b>Chorus Mode</b> • A tone other than the Song Sequencer is selected by Zone Part 1, and the Chorus is selected by “Chorus/DSP Select” (page E-38).	(2) Chorus	Depends on the mixer chorus send value (page E-80) and the selected tone chorus send value (page E-29).
<b>Normal DSP Mode</b> • A tone other than the Song Sequencer is selected by Zone Part 1, and the DSP is selected by “Chorus/DSP Select” (page E-38).	(3) Normal DSP	(3) is applied only to parts whose mixer DSP line (page E-80) is on.
<b>Solo Synthesizer Tone Mode</b> • Solo Synthesizer tone selected by Zone Part 1.	(4) Solo Synthesizer DSP	(4) is applied only to Zone Part 1 and parts whose mixer DSP line is on.

### To configure effect settings

1. Hold down **13** EFFECT until the effect list top screen shown below appears.



**2.** Next, refer to the list below as you perform operations with the **17** controls to select items and change settings.

■ **Effect Settings**

Display	Description	Settings
Rev Type	Reverb type. Reverb effect type.	Type1, Type2
Rev Level	Reverb level. Reverb effect level.	0 to 127
Rev Time	Reverb time. Reverb sustain time.	0 to 127
Cho Level	Chorus level. Chorus effect level.	0 to 127
Cho Rate	Chorus rate. Rate of chorus effect undulation.	0 to 127
ChoSendRev	Chorus send level to reverb. Specifies how reverb is applied to the entire sound to which the chorus effect is being applied.	0 to 127
Cho/DSP	Chorus/DSP select. Selects use of either Chorus or Normal DSP ("Chorus and DSP Use Restrictions", page E-37).	Cho, DSP
DSP Select >Ent	Displays the main Normal DSP selection screen. <ul style="list-style-type: none"> <li>You will not be able to go any further if a Solo Synthesizer tone is selected for Zone Part 1.</li> </ul>	
(Normal DSP selection screen)	You can select from among preset and user tones for the Normal DSP using the same procedures as those for tone selection. <ul style="list-style-type: none"> <li>For a list of preset Normal DSPs, see the separate "Appendix". Selecting "ton" applies the initial preset DSP of each tone.</li> <li>Pressing <b>17</b> <b>EDIT</b> while this screen is displayed will change to the DSP editing screen (page E-39).</li> </ul>	ton Preset: 0-0 to 9-9 User: 0-0 to 9-9
Master EQ >Ent	Master equalizer setting group (item (5) of the "Effect Block Diagram" on page E-36)	
EQ Enable	Turning this setting off disables the Master EQ setting.	Off, On
Low Freq	Low frequency band. Adjusts the low frequency band.	200 Hz, 400 Hz, 800 Hz
Low Gain	Low gain. Adjusts the low gain.	-12 to 0° to +12
Mid1 Freq	Mid 1 frequency band. Adjusts the mid1 frequency band.	1.0 kHz to 5.0 kHz
Mid1 Gain	Mid1 gain. Adjusts the mid1 gain.	-12 to 0° to +12
Mid2 Freq	Mid 2 frequency band. Adjusts the mid2 frequency band.	1.0 kHz to 5.0 kHz
Mid2 Gain	Mid2 gain. Adjusts the mid2 gain.	-12 to 0° to +12
High Freq	High frequency band. Adjusts the high frequency band.	6.0 kHz, 8.0 kHz, 10.0 kHz
High Gain	High gain Adjusts the high gain.	-12 to 0° to +12



## Saving an Edited DSP

DSPs are divided among 53 DSP types according to effects. Preset Normal DSPs 0-0 and 0-1 are compressor type DSPs. There are two DSP types: a Normal DSP specific type and a Solo Synthesizer DSP specific type.

When editing and saving a DSP, you must first specify its type and then edit it in accordance with its type.

- For a list of DSP types, see “DSP Type List” on page E-99.

**1. Select the tone to which you want to apply the DSP. Next, on the editing screen of the tone, select DSP Edit >Ent (page E-29) and then press **17** ENTER to display the DSP editing screen shown below.**

- When editing a Normal DSP, you can display the DSP editing screen from the Normal DSP selection screen (page E-38) by pressing **7** EDIT.

DSP type number: type name

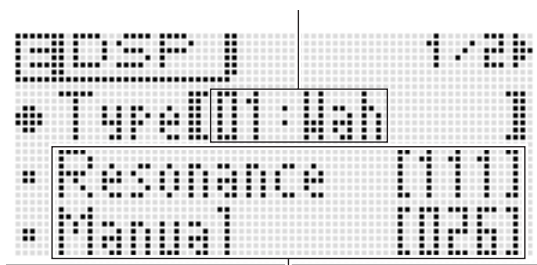

DSP parameter

**2. Use the **15** dial to select a DSP type number.**

**3. Use the same operation as these for tone editing (page E-20) to select and configure the DSP parameters on the screen.**

- DSP parameters depend on the DSP type. For details, see the “DSP Parameter List” (page E-100).

**4. After you finish editing a DSP, save it as described below.**

Press **7** WRITE to display the screen for saving a user tone. Save the data as a user tone (page E-12).

- **If you displayed the DSP editing screen from the Normal DSP selection screen (page E-38) in step 1** Press **7** WRITE to display the screen for saving a DSP. Save the edited DSP as a user DSP using the same operation as that for a user tone.

### ■ Saving a User DSP to an External Device

- Memory card (page E-86)
- Computer (page E-92)

# Sounding Arpeggios Automatically

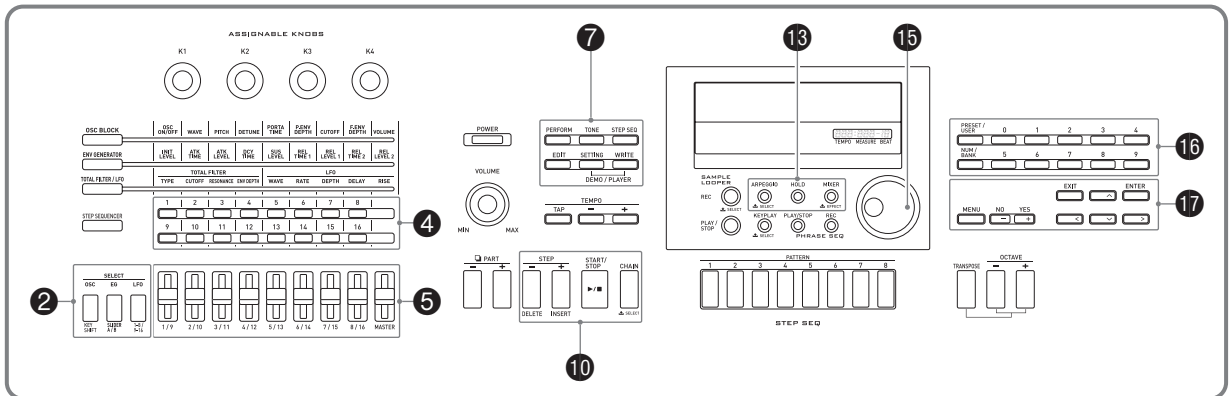

With the Arpeggio Function, you can play various arpeggios automatically by simply pressing keys on the keyboard. You can select from a number of different arpeggio types for playback, including arpeggios using the notes that make up a chord you play on the keyboard, arpeggios that also include notes that are automatically inserted in addition to those that make up a chord you play on the keyboard, and more.

- The Arpeggio Function has 100 arpeggio type presets. A type presets can be edited and saved as a user arpeggio type. There is memory for up to 100 user arpeggio types.
- The following functions are also available for selecting an arpeggio type.

**Hold (HOLD) :** The arpeggio continues to play after keyboard keys are released. This is useful, for example, when you use the Split Function to insert an arpeggio on one part of the keyboard.

**Sync (SYNC) :** The Step Sequencer automatically plays and stops in sync with the Arpeggio Function when keyboard keys are pressed.

2. Press **16** PRESET/USER to select preset arpeggios or user arpeggios.

- Preset arpeggios are selected while the button is unlit, while user arpeggios are selected while the button is lit.

3. Press the **16** NUM/BANK button so the button is flashing.

- While **16** NUM/BANK is flashing, the **16** (0 to 9) buttons can be used to input a bank number.

4. Use the **16** (0 to 9) buttons to select a bank number.

- Selecting a bank number will cause **16** NUM/BANK to stop flashing and become unlit. While **16** NUM/BANK is unlit, the **16** (0 to 9) buttons can be used to input an arpeggio number.

5. Use the **16** (0 to 9) to input an arpeggio number.

- You also can select an arpeggio number by rotating the **15** dial.
- One more way to change the arpeggio number is to use the **17** minus (-) and plus (+) buttons to decrease or increase the displayed arpeggio number. Pressing the **17** minus (-) and plus (+) buttons at the same time will jump to the first arpeggio number in the current selected category (see next section).

## To use the Arpeggio Function

1. Hold down **13** ARPEGGIO until the arpeggio type selection screen shown below appears on the display.

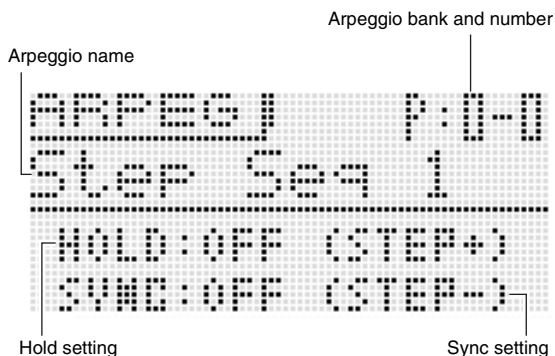

### 6. Select arpeggio hold or synchro ON/OFF.

- If you want to turn on the hold function (HOLD), press **10 STEP +**. Each press toggles HOLD between on and off.
  - OFF: The arpeggio will play while keyboard keys are depressed.
  - ON : The arpeggio will continue to play even after the keyboard keys are released
- If you want to turn on the sync function (SYNC), use **10 STEP -** to cycle through the available sync settings described below.
  - OFF: Sync setting is turned off.
  - ON : Arpeggio play is synced with only the play operation of the Step Sequencer.
  - S/S : Arpeggio play is synced with both the play and stop operations of the Step Sequencer.
- The HOLD and SYNC settings are performance parameters.

### 7. Press some keys and the arpeggio will start to play automatically.

- To turn off the Arpeggio Function, press **13 ARPEGGIO** again.
- To stop arpeggio HOLD playback, press **13 ARPEGGIO** or change the HOLD function in step 2 of the above procedure to OFF.

■ You can use the arpeggio type selection screen to select the recommended tone for the currently selected arpeggio type as your Zone Part 1 tone.

- Hold down **13 ARPEGGIO** until the arpeggio type selection screen appears on the display.
- Hold down **7 EDIT** until **13 ARPEGGIO** starts to flash and then stops flashing to remain lit.
  - In the case of a user arpeggio, the tone that was selected as the Zone Part 1 tone when the user data was saved is the recommended tone.

## Editing an Arpeggio

There are two arpeggio types: step type and variation type.

- With a step type arpeggio, you can edit its steps and its parameters. A step type arpeggio can contain up to 16 steps. You can change the following values for each step.
  - TYPE : Specifies the relative position in the arpeggio pattern where each of the keyboard notes will play. You can specify positions starting from the lowest note played (L1) or from the highest note played (U1). You can even specify simultaneous play of up to five notes (P2 through P5).
  - NOTE: Specifies a relative shift, in semitone steps, from the note played on the keyboard.
  - VELO: Specifies the volume of the note.
- With a variation type arpeggio, you can edit only its parameters.

- Hold down **13 ARPEGGIO** until the arpeggio type selection screen shown below appears on the display.
- From among the preset or user arpeggio types select the arpeggio type you want to edit.
  - For information about how to select an arpeggio type, see steps 2 through 5 under “To use the Arpeggio Function” (page E-40).

### 3. Press **7 EDIT**.



- Use the **17 up (^)** and down (**17 down (v)**) buttons to move the item selection cursor (**●**) to “Step Edit”, and then press **17 ENTER**.

- The “Step Edit” option will not be displayed if you selected a variation type arpeggio in step 2 above.

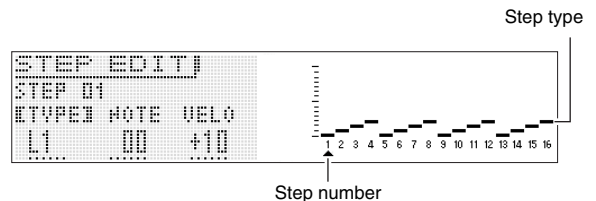

Step type

**5. Use the **15** dial or the **17** minus (–) and plus (+) buttons to change the TYPE, NOTE, and VELO settings.**

- You can also use the **4** **1 to 16** buttons to toggle each step on or off.
- While **TYPE** is selected, use the **17** **minus (–) and plus (+) buttons** to turn the **TYPE** setting on or off.
- You can use **5** (eight sliders excluding “MASTER”) to change the values of the applicable step directly. When using the sliders, press **2** **1-8/9-16** to toggle between steps 1 through 8 (button unlit) and steps 9 through 16 (button lit). Note, however, that you will not be able to use the sliders when **TYPE** is **TIE** and **OFF**.
- You can specify the tie setting. For details how, see “To configure tied note settings” on page E-53.
- The table below shows the contents of the arpeggio step editing menu.

Menu Layer		Description	Settings
1	2		
Step Edit >Ent			
TYPE		Specifies the relative position in the arpeggio pattern where the keyboard notes will play starting from the lowest note played (which is L1). <ul style="list-style-type: none"> <li>• If the number of keys pressed is less than the number of configured type (L) settings (i.e. if you press only three keyboard keys for an arpeggio pattern that includes settings for L1 through L6), the arpeggio pattern will repeat, playing the keyboard key notes one octave higher.</li> <li>• At any point the above causes the range of one higher octave to be exceeded, arpeggio play will return to the L1 note automatically.</li> </ul>	L1 to L8
		Specifies the relative position in the arpeggio pattern where the keyboard notes will play starting from the highest note played (which is U1). <ul style="list-style-type: none"> <li>• If the number of keys pressed is less than the number of configured type (U) settings (i.e. if you press only three keyboard keys for an arpeggio pattern that includes settings for U1 through U6), the arpeggio pattern will repeat, playing the keyboard key notes one octave lower.</li> <li>• At any point the above causes the range of one lower octave to be exceeded, arpeggio play will return to the U1 note automatically.</li> </ul>	U1 to U8
		Specifies how many of the notes played on the keyboard, starting from the highest note played, should be played simultaneously. <ul style="list-style-type: none"> <li>• When the number of keys pressed is less than the polyphony (P) value specified here, only the notes that are played are sounded.</li> </ul>	P2 to P5
NOTE		Shifts the notes produced by pressing keys in semitone steps.	–24 to +24
VELO		Changes the velocity of pressed keys.	–64 to +63

**6. After the TYPE, NOTE, and VELO settings are the way you want, press **17** EXIT to return to the arpeggio menu screen.**

**7. Use the **17** up (^) and down (v) buttons to move the item selection cursor (●) to “Parameter”, and then press **17** ENTER.**

**8. Use the 15 dial or the 17 minus (-) and plus (+) buttons to change the parameter settings.**

- The table below shows the contents of the parameter editing menu.

Menu Layer		Description	Settings
1	2		
Parameter >Ent			
	Max Step	Maximum step. Can be edited only by step type.	1 to 16
	Step Size	Step size. Specifies the note length between steps.	
	NoteLngth	Note length. Specifies the length of the note that is sounded as a percentage of the step size. (100% for the same length as the original, 50% for half the original.)	1 to 100%
	Groove	Groove. Specifies the timing of the up beat step. (50% for even. Larger values increase the length of the first half of the note.)	10 to 90%
	Grv.Type	Groove type. Specifies the note length when the Groove setting is anything besides 50%.	Norml: Plays back at the actual percentage of the step length. Short: Adjusts to a short step in accordance with the step.
	Velocity	Velocity. Specifies the velocity of an input arpeggio. Specifying KeyOn inputs a velocity value in accordance with the degree of key pressure applied.	KeyOn, 1 to 127
	Hold Pedal	Hold pedal. Specifies on/off switching for hold used by a pedal.	On, Off

**9. After you finish arpeggio parameter editing, save it as described below.**

- Press **7 WRITE** to display the screen for saving arpeggio data. Save the arpeggio by performing the same operation as that for saving a user tone (page E-12).
- For information about deleting data you saved, see page E-83.

**■ Saving Arpeggio Data on an External Device**

- Memory card (page E-86)
- Computer (page E-92)

## Clearing Arpeggio Data

Use the procedure below to clear preset step data or step data that was edited using Step Edit (page E-42) and create new step data from scratch.

- Note that variation type data cannot be cleared.

1. Hold down **13** ARPEGGIO until the type selection screen shown below appears on the display.
2. From among the preset or user arpeggio types select the arpeggio type you want to clear.
  - The procedure for selecting an arpeggio type is the same as that for selecting a tone (page E-19).
3. Press **7** EDIT.
4. Use the **17** up ( $\wedge$ ) and down ( $\vee$ ) buttons to move the item selection cursor ( $\bullet$ ) to “Clear Step”, and then press **17** ENTER.



5. Press **17** ENTER again.  
This should cause “Clear?” to appear on the display.
6. Press **17** YES.  
The message “Complete!” will appear on the display when the data is cleared.

# Recording and Playing Back Phrases

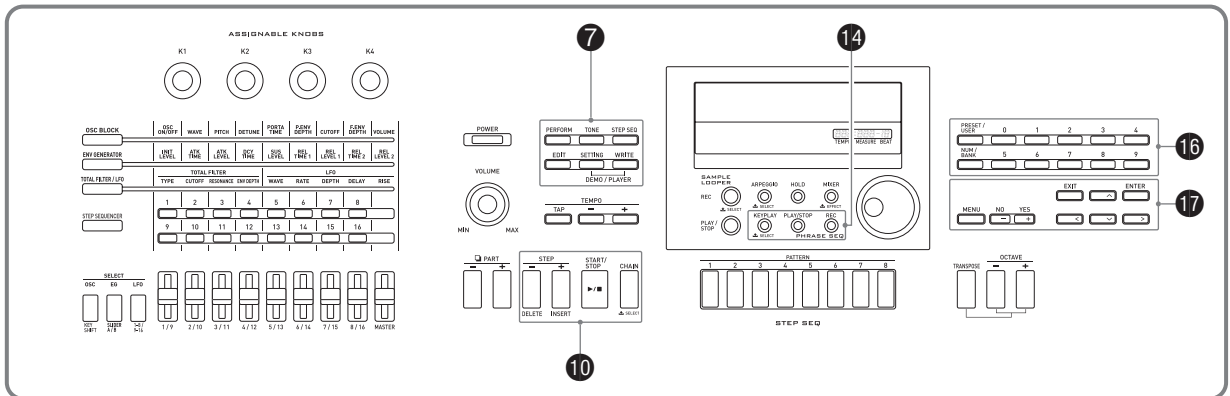

The Phrase Sequencer is a great way to record musical phrases that suddenly pop into your mind for later playback.

- The Sequencer has 100 preset phrases.
- You can record a new phrase or overdub onto an existing phrase to create a user phrase. There is memory for storage of up to 100 user phrases for later recall when you need them.
- In addition to what you play on the keyboard, your pedal, wheel, and knob operations are also recorded as part of phrase.
- You can choose either of two different playback options: one-time playback (loop off) or repeat playback (loop on).
- Overdubbing during looped playback is supported. You also can temporarily cancel overdubbing and perform looped playback only.
- Pressing a keyboard key will start playback of the phrase from the corresponding pitch (Key Play).

**3. Press 10 STEP + to toggle looping between on and off.**

- OFF : One-time playback
- ON : Looped playback

**4. Press 10 STEP – to toggle hold between on and off.**

- OFF : Phrase plays back only while 14 PLAY/STOP is depressed, and stops when the button is released.
- ON : Phrase playback starts when 14 PLAY/STOP is pressed and stops when 14 PLAY/STOP is pressed again.

**5. Press 14 PLAY/STOP to start phrase playback.**

- If the phrase is looped, the 14 PLAY/STOP light will go out momentarily to indicate when playback returns to the beginning of the phrase.
- You can also use the above procedure to play back user phrases as well.
- Phrase loop and hold settings are saved as parameters for each phrase.

## To play back a preset

**1. Hold down 14 KEY PLAY until the preset phrase selection screen shown below appears on the display.**



**2. Select the number of the phrase you want to play.**

- To select a phrase number, perform steps 2 through 5 under "To use the Arpeggio Function" (page E-40).

## To change the tempo setting

There are two different methods you can use to change the tempo setting: using the TEMPO buttons or tapping a beat with a button.

- You can use this procedure to adjust the tempo not only for phrases, but also for other functions as well.

### To change the tempo using the TEMPO buttons

#### 1. Press the **8** TEMPO – (slower) or **8** TEMPO + (faster) button.

- This displays the tempo screen shown below.



- If you do not perform any operation for a few seconds, the display will return to previous screen automatically.

#### 2. Use the **8** TEMPO –, + buttons to change the tempo (beats per minute).

- Holding down either button or rotating the dial will scroll the tempo values at high speed.
- You can specify a tempo value in the range of 30 to 255.

#### 3. Press the **17** EXIT button.

- This exits the tempo screen.

### To adjust the tempo by tapping a beat

#### 1. TAP the **8** TAP button four times at the speed (tempo) you want to set.



- The tempo setting will change in accordance with your tapping speed as soon as you tap the fourth time.

#### 2. After setting the tempo by tapping, you then can use the procedure under “To change the tempo using the TEMPO buttons” (page E-46) to make fine adjustments.

You can use the phrase selection screen to select the recommended tone for the currently selected phrase as your Zone Part 1 tone.

- Hold down **14** KEY PLAY until the phrase selection screen appears on the display.
- Hold down **7** EDIT until **14** KEY PLAY starts to flash.
  - In the case of a user phrase, the tone that was selected as the Zone Part 1 tone when the user data was saved is the recommended tone.

## To start phrase playback by pressing keyboard key (Key Play)

- Press **14** KEY PLAY so the button becomes lit.
- Press keyboard key to start playback of the phrase.
  - If the key you press to start phrase playback is higher or lower than the phrase’s original pitch, the phrase will play at the pitch of pressed key.
  - When the hold setting is turned off, the phrase is played only while the keyboard key is depressed, and stops when the key is released. When the hold setting is turned on, phrase playback starts when the keyboard key is pressed and does not stop until the **14** PLAY/STOP key is pressed.
  - You can use the “PhrKeyRgLo” and “PhrKeyRgHi” settings to specify the high point and the low point of the keyboard where Key Play can be performed (page E-75).



## Recording a New Phrase

In addition to what you play on the keyboard, pedal, knob, and wheel operations are also recorded in phrases.

- You can record up to approximately 1,600 notes for a single phrase. Also, recorded wheel and knob operations significantly reduce the remaining number of notes available for recording.

### 1. Press **14** REC.

This will cause the **14** REC light to flash.

- If OVDB (overdubbing) is displayed as the “Rec Mode” setting, use the **17** minus (–) and plus (+) buttons to change it to NEW (new phrase). This will enter the new phrase recording standby mode.



- End quantize and note quantize settings can be configured as required.

#### ■ End Quantize (End Qntz)

When you perform a button operation to end recording of a new phrase, there is a chance that your timing may be off. The end quantize settings described below can be used to correct the timing of the end point automatically and make its positioning more natural.

Off: Phrase end point timing not adjusted.

1M: Phrase end point is adjusted to measure-unit positions.

♩ : Phrase end point is adjusted to quarter note-unit positions.

♪ : Phrase end point is adjusted to eighth note-unit positions.

#### ■ Note Quantize (Note Qntz)

When recording keyboard play, there may be cases when your timing strays a bit. The note quantize settings described below can be used to correct the timing of keyboard play automatically and correct the timing of notes you play on the keyboard. (Note that only key press timing is correct. The timing of other operations such as key release, and wheel, pedal, and knob operations are not corrected.)

Off : Timing not adjusted. (Notes are recorded as played.)

♪, ♩, ♪, ♫ : Timing of actual keyboard play is corrected to the nearest note in accordance with the specified note unit.

- Pressing **17** MENU will display a menu of the detailed settings shown below. Use the **17** up (∧) and down (∨) buttons to select a parameter and then use the **17** minus (–) and plus (+) buttons to change its setting.



Menu	Description	Setting Range
Guide	Guide tone. Specifies whether or not a count tone is sounded during phrase recording and/or record standby.	Off, On
Precount	Precount. Specifies the number of measures of count to be inserted prior to the start of button operation triggered phrase recording.	Off, 1:1 measure, 2:2 measures
Beat	Beat. Specifies the beat when Guide, Precount, or end quantize 1M is being used.	2/4 to 8/4, 2/8 to 16/8

### 2. Recording will start when you press the **14** REC, or when you start to play by performing a pedal, knob, or wheel operation or play something on keyboard.

**14** REC will light when recording starts.

### 3. When recording reaches the point where you want to stop, press **14** PLAY/STOP.

**14** REC will become unlit and “!TEMP” (temporary) will appear for the phrase number.

- Pressing **14** REC in place of **14** PLAY/STOP in step 3 above will stop recording, temporarily change to the overdub standby mode, and start looped playback of the phrase you have recorded. For details about overdubbing, see “Recording Over Another Phrase (Overdubbing)” (page E-48).

### 4. After you finish recording, save the data as described below.

- Press **7** WRITE to display the screen for saving a phrase (page E-49).
- For information about deleting data you saved, see page E-83.

#### ■ Saving a Phrase to an External Device

- Memory card (page E-86)
- Computer (page E-92)

## Phrase Data Settings

When playing on keyboard to start phrase playback (page E-46), the phrase data will play back in the key it was originally recorded in (Original Key) if you press the key for the first note recorded in the phrase.

Phrase data settings can be used to specify that playback should be performed using the originally recorded notes, even when keyboard keys are pressed for notes other than those in the original phrase data. Each phrase has a Key Shift setting that you can use to change the pitch of the original key in semitone steps.

1. Hold down **14** KEY PLAY until the phrase selection screen appears on the display.
2. Select the number of the phrase whose settings you want to configure.
  - To select a phrase number, perform steps 2 through 5 under “To use the Arpeggio Function” (page E-40).
3. Press **7** EDIT.



4. Use the **17** up (^) and down (v) buttons to select a parameter and then use **16** or the **17** minus (-) and plus (+) buttons to change its setting.

Menu	Description	Setting Range
OriginalKey	Original Key. Specifies the keyboard key that corresponds to the first note of the phrase played by Key Play. (The initial Original Key default settings the note played when the phrase was recorded.) • Setting can be specified using the keyboard keys.	C- to G9*
Key Shift	Key shift. Specifies the key shift, in semitone steps, of a phrase when the keyboard key corresponding to the original is or the PLAY/STOP key is pressed. (To disable key shift, specify 000.)	-127 to 000 to +127

\* “C-” on the display indicates C-1 (one octave below C0).

5. After you finish configuring settings, save them as described below.

- Press **7** WRITE to display the screen for saving a phrase (page E-49).
- For information about deleting data you saved, see page E-83.

### ■ Saving a Phrase to an External Device

- Memory card (page E-86)
- Computer (page E-92)

## Recording Over Another Phrase (Overdubbing)

1. Select the phrase you want to overdub.
  - To select a phrase number, perform steps 2 through 5 under “To use the Arpeggio Function” (page E-40).

2. Press **14** REC.

This will cause **14** REC to flash.

- If NEW is displayed as the “Rec Mode” setting, use the **17** minus (-) and plus (+) buttons to change it to OVDB (overdubbing). This will enter the overdubbing standby mode. A phrase number and name will be shown on the display, but you cannot select a phrase at this time.



- If you want, configure the note quantize (Note Qntz) setting (page E-47) at this time.

3. Press **14** REC or start playing with a pedal, knob, or wheel operation, or by playing something on the keyboard. Any one of these operations will start overdub recording.

This will cause **14** REC and **14** PLAY/STOP to light (without flashing).

- The original phrase will playback as a loop. Anything you play on the keyboard and any operations you perform during loop playback will be overdubbed onto the original phrase.

4. When recording reaches the point where you want to stop, press **14** PLAY/STOP.

**14** REC and **14** PLAY/STOP will become unlit and an exclamation point (!) will appear next to the phrase number.

### ■ To pause overdubbing during looped playback

In step 4 of the above procedure, press **14 REC** instead of **14 PLAY/STOP**.

- This will cause **14 REC** to start flashing.
- Though what has been recorded up to that point continues to play as a loop, further recording is not possible while overdubbing is paused.
- Press **14 REC** again to resume overdubbing.

### ■ To delete the last recorded data (undo)

While phrase playback is in progress or stopped, or while overdubbing is in progress or paused, hold down **14 REC** until the undo screen appears.

```

PHRASE | P:0-0
-----
PHRASE : UNDO
-----
HOLD: ON (STEP-)
  
```

- The message “Can’t UNDO” will be appear on the display if you try to perform an undo operation again after already undoing the last recording.

```

PHRASE : Can't UNDO
-----
  
```

- A phrase that has been saved as a user phrase cannot be undone.

## Indicators Next to Phrase Numbers

The meanings of the indicators that are appended to the phrase number on the display are described below.

- ! : Unsaved phrase
- \* : Saved user phrase

!TEMP: Newly recorded phrase that has not been saved

- If you change the phrase number selection in step 2 of the procedure under “To play back a preset” (page E-45) while an exclamation point (!) is appended to the currently selected phrase number (indicating that it is an unsaved user phrase), the unsaved user phrase will be discarded. To save an unsaved user phrase, use the procedure under “To save a phrase”, below.

## To save a phrase

Press **7 WRITE** to display the screen for saving a phrase. Save the phrase by performing the same operation as that for saving a user tone (page E-12).

```

PHRASE | P:0-00
-----
(SIZE:1118 BYTE)
SynthPhrase1
-----
...Press Enter
  
```

- If there is not enough Synthesizer memory space available to store the phrase data, the message “not enough space” will appear on the above display in place of “Press Enter”, and you will not be able to save the phrase data. If this happens, delete some of the user data in Synthesizer memory to free up memory space.
- The Synthesizer can store up to 100 user phrases with a combined total of up to 128KB.
- For information about deleting phrase data you saved, see page E-83.

### ■ Saving a Phrase to an External Device

- Memory card (page E-86)
- Computer (page E-92)



# Using the Step Sequencer

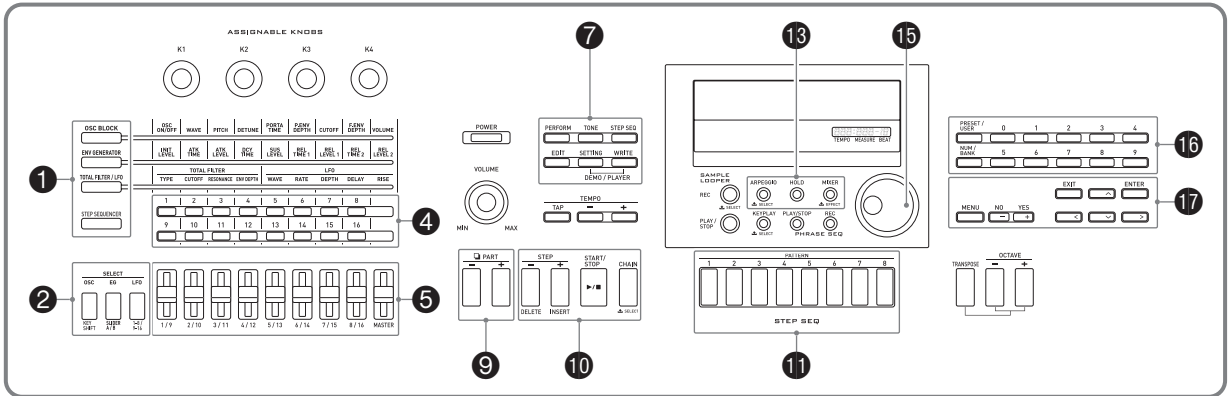

The Step Sequencer provides up to 16 steps. The Synthesizer's sliders can be used to control step notes and velocity in real time. The Step Sequencer is not just a rhythm machine, it makes it possible for you to compose music as you play on the keyboard. You can edit each step of a preset sequence to create your own rhythm pattern and save the result as a user sequence.

- The Step Sequencer has 100 preset sequences. You also can store up to 100 of your own user sequences.
- There are two ways to edit a step: simple editing without using the editing screen, and the editing screen that provides more detailed modification of a step.
- Wheel (bender, modulation) and knob operations can also be recorded as part of a sequence.
- Up to 99 different patterns can be chained together with the Step Sequencer and played back as a loop. You can store up to 100 chained sequences.
- Phrase Sequencer playback can be started from the Step Sequencer.

## How the Step Sequencer is organized

The following describes the configuration of a single sequence.

- A part (PART) consists of nine note parts (Drum 1 to 5, Bass, Solo 1 and 2, Chord) and four control parts.
- The control parts can be configured with pitch bends/control changes and Phrase Sequencer play triggers (that start and stop playback).
- For details about the settings and other information about each part, see "Editing a Sequence - Advanced" on page E-56.
- Each sequence has eight different patterns. You can configure separate beat (Beat Info) for each of the eight patterns.
- A track consists of data 16 steps along with their track parameters.
- You can use the Synthesizer's mixer function to change Step Sequencer tones. For details, see "Using the Mixer" on page E-78.

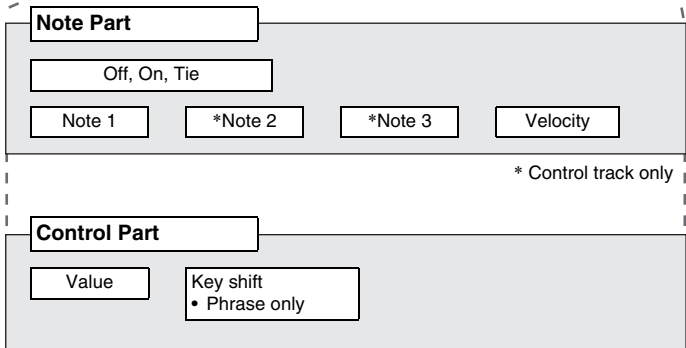
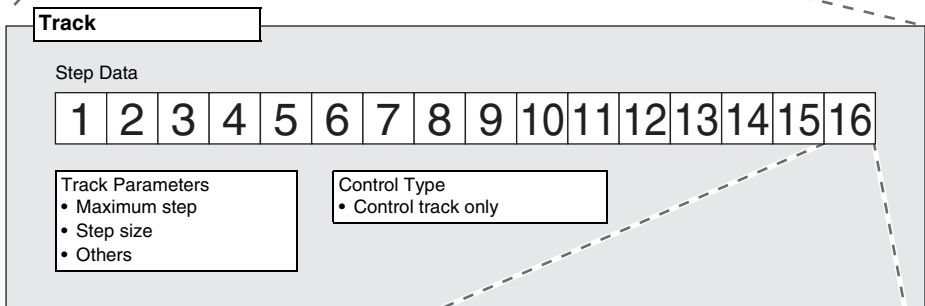
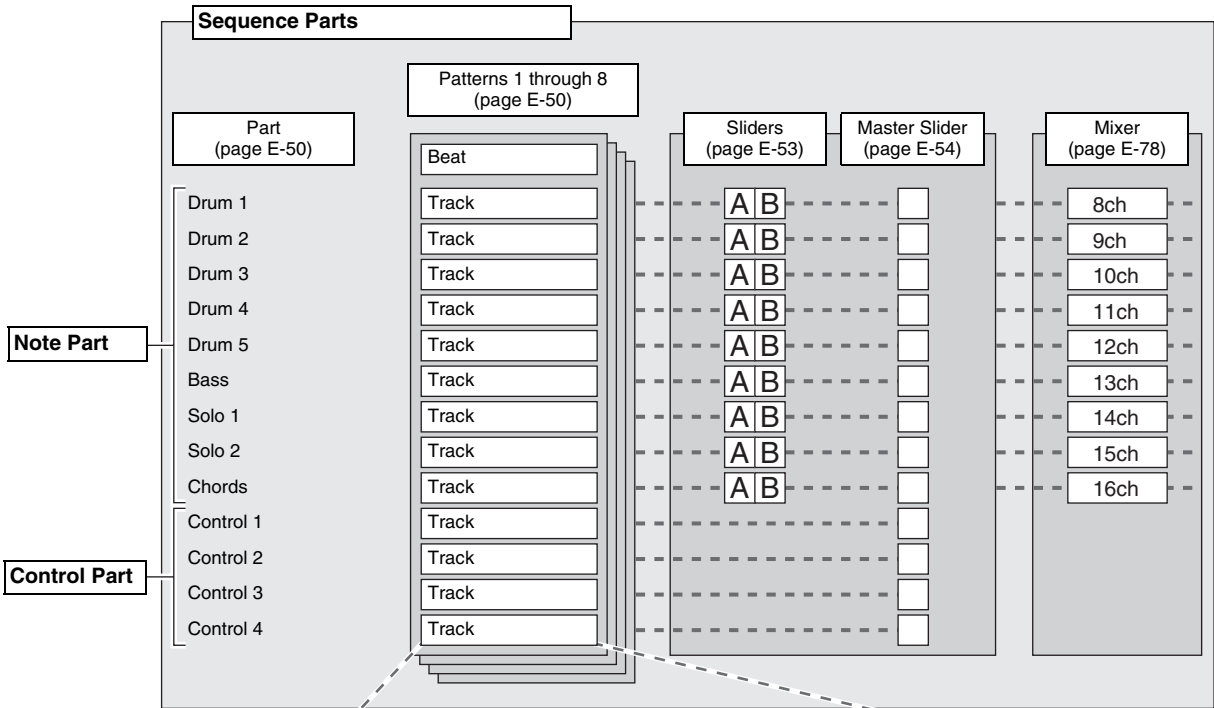

## Playing Back a Step Sequence

A step sequence can be played back from the Performance, Tone, or Step Sequencer Mode.

The step sequence can be changed by switching to a different pattern, selecting a different sequence bank and number, and by shifting the key (Key Shift).

### IMPORTANT!

- If the **10 CHAIN** button is lit (indicating the Chain Mode), press **10 CHAIN** to turn off the light before starting the procedure below.

#### 1. Press **10 START/STOP**.

The **10 START/STOP** button will flash and sequence playback will start.

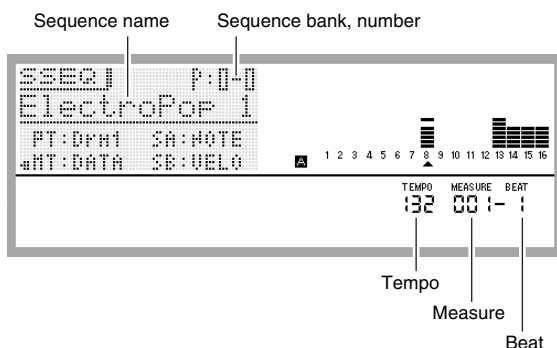

- Pressing **10 START/STOP** while playback is in progress will stop the sequence and cause the **10 START/STOP** button light to go out.
- Step Sequencer playback can be performed automatically, without pressing **10 START/STOP**, by using the Arpeggio Function to specify Step Sequencer playback triggers. For details, see the section of this manual from “To use the Arpeggio Function” on page E-40.
- For information about changing the playback tempo, see “To change the tempo setting” (page E-46).

#### 2. To change to a different pattern, enter the Step Sequencer Mode and press one of the **11 PATTERN 1 to 8** buttons.

The light of the button whose pattern you select will go out.

- When changing to a different measure, the light of the button of the currently selected pattern will flash until a point is reached where the change can be made.
- Pressing the button of the currently selected pattern will cause its button light to flash, indicating that playback is standing by to stop. Next, pressing **10 START/STOP** will stop playback when it reaches the end of the currently playing measure. To cancel the stop standby operation described above, press the flashing button again.

#### 3. If you want to change to a different sequence, enter the Step Sequencer Mode and change the sequence bank and/or number.

- To select a sequence, perform steps 2 through 5 under “To use the Arpeggio Function” (page E-40).

#### 4. If you want to shift the key, press **1 STEP SEQUENCER** and then press **2 KEY SHIFT**.

- When the original key is C2, you can shift the key by pressing a keyboard key within the range of D2 to B2.
- You can specify whether or not to shift the key of each individual part. For details, see the section of this manual from “Editing a Sequence - Advanced” on page E-56.
- The Key Shift on/off setting is saved as Performance parameter.

## Editing a Sequence -Simple Editing

Simple editing of a sequence can be performed from the Performance, Tone, or Step Sequencer Mode.

### IMPORTANT!

- If the **10 CHAIN** button is lit (indicating the Chain Mode), press **10 CHAIN** to turn off the light before starting the procedure below.

#### 1. If the Synthesizer is in the Performance or Tone Mode, press **1 STEP SEQUENCER**.

This enters the Step Sequencer Mode, which causes the **1 STEP SEQUENCER** button to light.

#### 2. Perform steps 1 through 3 of the procedure under “Playing Back a Step Sequence” on page E-52 to select the sequence and pattern you want to edit.

#### 3. Use the **9 PART** minus (–) and plus (+) buttons to select the part you want to edit.

A pointer (▲) will appear on the display under the number of the currently displayed part.

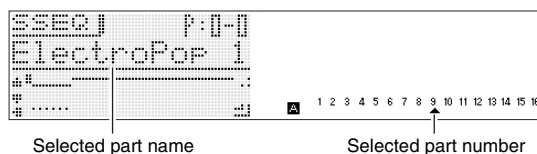

- The pointer (▲) does not appear on the display if you select a control type part.

#### 4. Edit each part using the procedures in the following sections.

## To turn a step on or off

### ■ On (Sounding)

Press the **4 1 to 16 button** of the number of the step you want to turn on.

When a step is on, its **4 1 to 16 button** is lit and NOTE is displayed next to its step number.



### ■ Off (Not sounding)

Press the **4 1 to 16 button** of the number of the step you want to turn off.

When a step is turned off, the light of its **4 1 to 16 button** is unlit and OFF is displayed next to its step number.



- There is no step on/off setting for a control part.

## To configure tied note settings

1. While holding down **1 STEP SEQUENCER**, press the **4 1 to 16 button** that corresponds to the step number of the first note of the tied group.



First step number

2. Next, while holding down **1 STEP SEQUENCER**, press the **4 1 to 16 button** that corresponds to the step number of the last note of the tied group.



Last step number

- This turns on the step you specified as the start of the tied group. It also ties together all of the notes from the first step up to the last step.
- The **4 1 to 16 buttons** that correspond to the step numbers included in the tied group will all be flashing. Release **1 STEP SEQUENCER** and the button lights will go out. (Even though the button lights go out, the notes in the group remain tied.)
- To check which steps are tied, hold down **1 STEP SEQUENCER** and then press any one of the **4 1 to 16 buttons**. This will cause the **4 1 to 16 buttons** of the steps included in the tied group to flash.
- A control part does not have a tie setting.

## Using the Sliders to Change Note and Velocity Settings

### ! IMPORTANT!

- If the **1 STEP SEQUENCER** button is not lit, press **1 STEP SEQUENCER** to turn on the light before starting the procedure below.

### ■ Slider Operations

Use **5 1/9 to 8/16** to change the note and velocity settings (note part) of the notes of steps 1 through 16.

- In the case of a control part, the sliders can be used to change the control effect. For details, see "Editing a Sequence - Advanced" on page E-56.
- Press **2 1-8/9-16** to toggle slider operations between steps 1 through 8 and steps 9 through 16.
- Step 1 through 8 operation is selected when the **2 1-8/9-16 button** is unlit. Step 9 through 16 operation is selected when the **2 1-8/9-16 button** is lit.

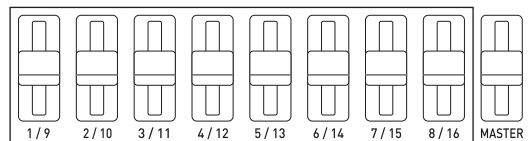

Steps 1 through 8 or steps 9 through 16 (selectable)



### ■ Selecting a Slider Function

Pressing **2** SLIDER A/B toggles the sliders between two functions.

Example: Preset sequence

- 2** SLIDER A/B unlit: **A** (NOTE)
- 2** SLIDER A/B lit: **B** (VELOCITY)

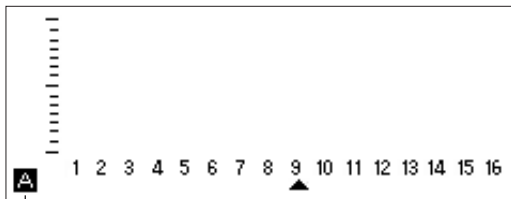

Indicates the selected function as **A** or **B**.

- Moving a **5** 1/9 to 8/16 slider will turn on the corresponding step, even if it is currently turned off.
- Slider function switching cannot be performed for a control part.

### Using the Master Slider to Change Note and Velocity Settings

You can use the **5** MASTER slider to batch change the settings (note, velocity, staccato/tenuto, playback speed, groove) of all of the parts.

- The settings that can be changed using the master slider depend on the part type.
- For some parts, the master slider cannot be used to change settings.
- You can assign other settings to the master slider, if you want. For more information, see “Changing the Function Assigned to the Master Slider” on page E-54 and “Changing Slider Settings” on page E-60.

### Changing Slider Assignments

Under default settings, the A sliders have note settings assigned to them, while the B sliders have velocity settings assigned. You can use the procedure below to assign note settings, velocity settings, or both note and velocity settings to sliders.

You also can specify the note or velocity setting that is selected at each of the eight slider positions.

1. Press **1** STEP SEQUENCER.
2. Hold down **2** SLIDER A/B until the SLIDER screen shown below appears.



3. Use the **9** PART minus (-) and plus (+) buttons to select the part whose slider assignments you want to change.

4. Press **2** SLIDER A/B to select the set of sliders (A or B) whose assignments you want to change.

5. Move the display cursor to “TYPE” and then use the **17** NO and YES buttons to assign one of the following functions to the selected sliders.

- NOTE : Note
- VELO : Velocity
- NOTE & VELO : Both note and velocity

6. Use the **15** dial, the **17** up (^) and down (v) buttons, or the **11** PATTERN (1 to 8) buttons to move the display cursor to the slider position (1 to 8) whose setting you want to change.

- The numbers 1 through 8 indicate the eight slider positions, from top (8) to bottom (1).

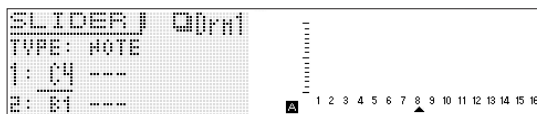

7. Use the **17** NO and YES buttons to change the note or velocity value at the currently selected slider position.

- You can also press the keyboard key that corresponds to the note you want to input to specify the note and velocity for the currently selected slider position.
- For a chord part, you can specify up to three values.
- Use advanced parameter editing to edit slider functions. For details, see “Editing a Sequence - Advanced” (page E-56).

### Changing the Function Assigned to the Master Slider

1. Press **1** STEP SEQUENCER.
2. Hold down **2** SLIDER A/B until the SLIDER screen appears.
3. Press **17** MENU and then press the **17** right (>) button to move the item selection cursor (●) to “M.Slider”.



**4. Press  $\text{F17}$  ENTER.**

This will display the master slider setting screen.



**5. Use the  $\text{F17}$  minus (-) and plus (+) buttons and the  $\text{F9}$  PART minus (-) and plus (+) buttons to display the name of the part you want to change to inside the brackets [ ] next to Part.**

**6. Use the  $\text{F17}$  up (^) and down (v) buttons to move to the “Assign” setting, and then use the  $\text{F15}$  dial or the  $\text{F17}$  minus (-) and plus (+) buttons to change to one of the settings described below.**

Assign	Description
Nop	No operation. Master slider operation is disabled.
S. Data	Step data. Changes the data of all of the steps (1 thorough 16) that are currently turned on.
S. Size	Step size
NoteLn	Note length
Groove	Groove
Octave	When there are notes assigned to sliders 1 through 8, moving the master slider when this setting is in effect will change the octaves of the notes (Range: -1 to 0 to 1).

- For details about step size, note length, and groove assignments, see “Step Sequencer Parameters” on page E-57.

**NOTE**

- Slider functions can also be modified as described below. For information about making these changes, see “Changing Slider Settings” on page E-60.
  - Copying settings from another slider
  - Scale, drum, velocity slider presets
  - Note shift

**Inputting Step Data by Playing on the Keyboard, etc.**

You can input note, velocity, and other step data by performing keyboard, pitch bend, and knob operations as you play.

- When inputting a pitch bend or knob operation, you first need to use the control track to select the pitch bender or knob and then perform an input.

**1. Press  $\text{F7}$  EDIT.**

**2. Use the  $\text{F17}$  down (v) button to move the item selection cursor (●) to “Step Edit”, and then press  $\text{F17}$  ENTER.**

**3. Input data as described below.**

**■ While sequence playback is in progress**

Press keyboard keys and perform other operations as required according to the timing of playback.

**■ While sequence playback is stopped**

Perform input into the currently displayed step.

**Changing the Solo1 Channel**

Solo1 is normally assigned to channel 14.

You can use the procedure below to change the assignment to channel 1 when you want to use Solo Synth or other special tones as the solo tone.

**1. Press  $\text{F1}$  STEP SEQUENCER.**

**2. Press  $\text{F17}$  MENU and then press the  $\text{F17}$  right (>) button.**

**3. After confirming that the item selection cursor (●) is next to “Setting”, press  $\text{F17}$  ENTER.**

**4. Use the  $\text{F17}$  up (^) and down (v) buttons to move the item selection cursor (●) to “Solo1 Ch”.**



**5. Use the  $\text{F17}$  minus (-) and plus (+) buttons to change the Solo1 channel setting.**

1 : Channel 1

14 : Channel 14

- The Solo1 channel setting is saved as Performance parameter.

## Changing the Timing of Pattern Switching

1. Perform steps 1 through 3 of the procedure under “Changing the Solo1 Channel” on page E-55.
2. Use the **17** up ( $\wedge$ ) and down ( $\vee$ ) to move the item selection cursor ( $\bullet$ ) to “Pattern Change Timing”.



3. Use the **17** minus (-) and plus (+) buttons to select one of the pattern switching timings described below.

Wait : Wait until the start of the next measure.

Real : Switch immediately, even if it is partway through a measure.

Beat : Switch at the beginning of the beat.

- The pattern switching timing setting is saved as Performance parameter.

## Syncing Step Sequencer Playback with an Arpeggio

See “To use the Arpeggio Function” on page E-40.

## Changing the Step Sequencer Tone

You can use the Synthesizer’s mixer function to change the Step Sequencer tone.

- Data assigned by the mixer to channels 8 through 16 is saved as Step Sequencer data.
- Mixer parameters are applied to all pattern parameters.
- For details, see “Using the Mixer” on page E-78.

## To sound a single part (solo mode)

1. Press **1** STEP SEQUENCER and then press **7** EDIT.
  - This step is not necessary if you already pressed **7** EDIT and are already editing a step sequence.
2. Press **13** MIXER.
3. Hold down the button (**4** 9 to 16 note part buttons) that corresponds to the part you want to solo.
  - To cancel the solo setting, exit the Step Sequencer Mode or display the Track On/Off screen (page E-57).
  - For details about mixer operations, see “Using the Mixer” on page E-78.

## Editing a Sequence - Advanced

You can use the procedures in this section for advanced, detailed editing of sequence parameters.

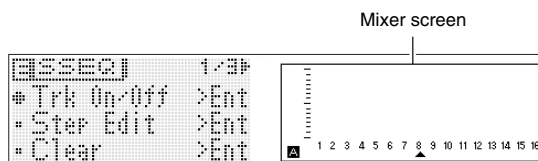

### To perform advanced parameter editing

1. Press **7** STEP SEQ.
2. Press **7** EDIT.

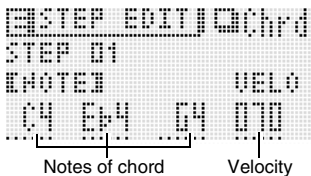

3. Use the **17** cursor ( $\leftarrow$ ,  $\wedge$ ,  $\vee$ ,  $\rightarrow$ ) buttons to move the item selection cursor ( $\bullet$ ) to the menu item for the edits you want to perform.

## ■ Step Sequencer Parameters

Level 1	Level 2	Level 3	Description	Setting Range and Screen Contents
Trk On/Off >Ent			Track editing (track on/off) • Pressing <b>7</b> EDIT while in the Step Sequencer Mode will display the same screen as Trk On/Off >Ent.	
	Pattern		Pattern number	1 to 8
	Part		Part name.	Drm1 to 5, Bass, Sol1 to 2, Chrd, Ctl1 to 4
	Track		Track on/off. Use <b>4</b> 1 to 16 to toggle. • <b>4</b> 1 to 4 correspond respectively to Control Parts 1 through 4. In the same way, <b>4</b> 8 to 16 correspond to Note Parts (page E-51).	Off, On
Step Edit >Ent			Step editing. Step-specific editing group.	
	Drm1 to 5, Bass, Sol1 and 2	NOTE, VELO	Selects off (OFF), on (NOTE), or tie (TIE) for a step. When on, note (NOTE) and velocity (VELOCITY) parameter settings are configured. The tie setting cannot be selected for Step 1.	Off, (When on) NOTE: C- to G9*, (When on) VELO: 1 to 127, Tie 
	Chrd	NOTE, VELO	Selects off (OFF), on (NOTE), or tie (TIE) for a step. When on, note (NOTE) and velocity (VELOCITY) parameter settings are configured. The tie setting cannot be selected for Step 1.	Off, (When on) NOTE: Off or C- to G9*, (When on) VELO: 1 to 127, Tie 
	Ctl1 to 4		Control part (Ctl) effects. Data of each part.	NOP: No operation. Other setting ranges are as shown below. Example screen shot below shows PHRASE screen. 
		BEND	Pitch Bender	-128 to +127
		CC1 to 97	MIDI control change.	0 to 127, Pan only -64 to +63
		K1 to 4	Knob operations specified by a Performance, etc.	0 to 127
		TEMPO	Tempo	30 to 255
		PHRASE	Specifies triggers for starting and stopping Phrase Sequencer playback. Display for Control 4 (Ctl4) only.	Nop: Disabled, Stop: Stop playback, Start: Start playback, -24 to +24: Shift from original key (When Start is selected)

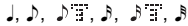
Level 1	Level 2	Level 3	Description	Setting Range and Screen Contents
Track Param >Ent			Track parameter	
	Max Step		Maximum step. Specifies the number of steps played back by a part. If the specified maximum number of steps is exceeded during playback, playback returns to the first step.	1 to 16
	Step Size		Step size. Specifies the note length between steps.	
	NoteLength		Note length. Note on note length specified as a percentage of the step size. 100% specifies the same size as the original, while 50% specifies a note length that is half the original.	1 to 100%
	Groove		Groove. Specifies the on note timing of the up beat step. The step note length changed alternately by step playback. 50% specifies even, while a larger value increases the first half note length.	10 to 90%
	Grv.Type		Groove type. Specifies the note on note length type when anything other than 50% is specified for Groove.	Norml: Normal Playback performed with length based on actual percentage. Short: When step length is changed by Groove, adjusts to the shorter length.
	Ctrl.Ch (Control part only)		Control Channel. Specifies the channel that applies the Control Track effect.	Channel 1, 8 to 16
	Smooth (Control part only)		Smooth. Controls Control Track playback. When on, control data is interpolated and played back.	On, Off
	Phrase No. (Control part 4 only)		Phrase Sequencer number. Specifies the Phrase Sequencer number to be controlled.	P00 to 99, U00 to 99
	Key Shift >Ent		Key shift editing group. This setting cannot be configured for Control 1 through 3. Real-time setting is not supported when Control 4 is configured to perform Phrase Sequencer key shift.	
		Enable	Key shift on/off	Off, On
		BreakPoint	Point between C and B where key shift drops the octave when the key is exceeded.	C to B
		Realtime	Real-time. Specifies breakpoint timing.	On: Change immediately Off: Change at the next note
Beat Info			Beat setting	2/4 to 8/4, 2/8 to 16/8

Level 1	Level 2	Level 3	Description	Setting Range and Screen Contents															
Copy >Ent			Data copy																
	Track		<p>Copies data from another track. Copies step data and part parameter data.</p> <ul style="list-style-type: none"> <li>Data being edited (TMP) can also be copied.</li> <li>The following are parts that can be copied.</li> </ul> <table border="0"> <tr> <td>From</td> <td></td> <td>To</td> </tr> <tr> <td>Dr1 to S2</td> <td>→</td> <td>Dr1 to S2</td> </tr> <tr> <td>Chord</td> <td>→</td> <td>Chord</td> </tr> <tr> <td>Ctrl1 to 3</td> <td>→</td> <td>Ctrl1 to 3</td> </tr> <tr> <td>Ctrl4</td> <td>→</td> <td>Ctrl4</td> </tr> </table>	From		To	Dr1 to S2	→	Dr1 to S2	Chord	→	Chord	Ctrl1 to 3	→	Ctrl1 to 3	Ctrl4	→	Ctrl4	<p>Copy source part name</p> <p>Copy source pattern number</p> <p>Copy source sequence (bank, number)</p> <pre> COPY T ACKN  From Trp P01 B S1  To P01 S2  ...Pres Enter  </pre> <p>Copy destination pattern number</p> <p>Copy destination part name</p>
From		To																	
Dr1 to S2	→	Dr1 to S2																	
Chord	→	Chord																	
Ctrl1 to 3	→	Ctrl1 to 3																	
Ctrl4	→	Ctrl4																	
	Pattern		<p>Copy data from another pattern.</p> <ul style="list-style-type: none"> <li>Data being edited (TMP) can also be copied.</li> </ul>	<p>Copy source pattern number</p> <p>Copy source sequence (bank, number)</p> <pre> COPY P ATTERN  From Trp P01  To P01  ...Pres Enter  </pre> <p>Copy destination pattern number</p>															
Note Shift >Ent			Note shift editing group																
	Shift		Specifies how much to shift in semitone steps.	-24 to +24															
	Ptn		Specifies a pattern to be shifted.	01 to 08															
	Part		Specifies a part to be shifted.	Dr1 to 5, Bas, Sl1 and 2, Chd															
Clear >Ent			Track data clear																
	Track	Pattern, Part	Selects a pattern and/or part inside a track.	Pattern: 01 to 16 Part: Drm1 to 5, Bass, Sol1 and 2, Chrd, Ctl1 to 4															
	Pattern		Clears all patterns.																
	Set		Clears all track (set) data.																
Slider Edit >Ent			<p>Step Sequencer Mode slider settings.</p> <ul style="list-style-type: none"> <li>When the <b>1 STEP SEQUENCER</b> button is lit, you could also hold down <b>2 SLIDER A/B</b> until the "TYPE" screen appears, and then perform the operations described below.</li> </ul>																
	TYPE		Changes the assigned slider function.	For details about the operation procedure and settings, see the procedure starting from step 3 under "Changing Slider Assignments" (page E-54).															
		Copy >Ent	Copies settings from another slider.	For details about the operation procedure and settings, see the procedure starting from step 4 under "Changing Slider Settings" (page E-60).															
		Preset >Ent	Scale, drum, velocity slider presets.																
		Note Shift >Ent	Note shift.																
		M.Slider >Ent	Changes the master slider function.	For details about the operation procedure and settings, see the procedure starting from step 5 under "Changing the Function Assigned to the Master Slider" (page E-54).															

\* "C-" on the display indicates C-1 (one octave below C0).

4. Use the **17** cursor (<, ^, v, >) buttons to move the brackets [ ] or the cursor to the item whose setting you want to change, and then use the **17** minus (-) and plus (+) buttons to change the selected setting.

- Use **11** **PATTERN** to change the pattern number.
- Use the **9** **PART** minus (-) and plus (+) buttons to change the part name.
- Use **10** **STEP** minus (-) and plus (+) buttons to change the step number.
- To return to the previous menu level, press **17** **EXIT**.
- The mixer screen shows current settings.
- While the Step Edit screen is displayed, the keyboard will sound the tone of the currently selected part. The mixer screen shows the settings of each step (the note, velocity or value item that is currently being changed). On the mixer screen, notes are shown in a specific position on the screen as C through B, regardless of the actual octave.

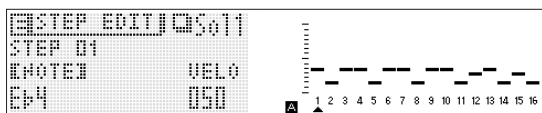

4. Use the **17** cursor (<, ^, v, >) buttons to move the item selection cursor (●) to the item you want and then press **17** **ENTER**. The items available on the screen are described below.

**■ Copy: Copies settings from another slider.**

Use the **17** cursor (<, ^, v, >) buttons to move the brackets [ ] to an item and then use the **17** minus (-) and plus (+) buttons to change the item's setting.

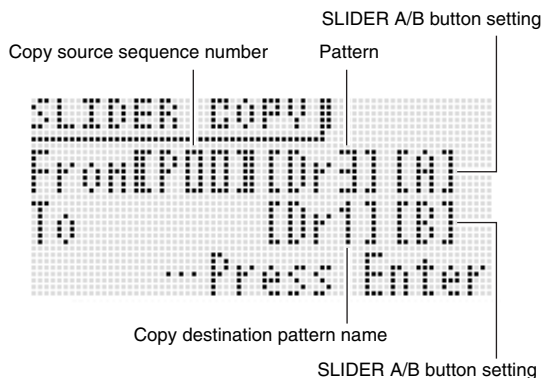

- Chord parts can be copied between chord parts only.
- Data being edited (!TEMP) can be specified as a copy source.

## Changing Slider Settings

In addition to the changes you can make using the simple editing procedures (page E-52), you can also do the following.

- Copy settings from another slider
- Scale, drum, velocity slider presets
- Note shift

### To copy slider settings from another slider

1. Press **1** **STEP SEQUENCER**.
2. Hold down **2** **SLIDER A/B** until a screen like the one shown below appears on the display.



3. Press **17** **MENU**.



### ■ Preset: Scale, drum, velocity slider presets

Use the **17** cursor (<, ^, v, >) buttons to move the brackets [ ] to an item and then use the **17** minus (-) and plus (+) buttons to change the item's setting. Inputting a slider preset number automatically causes the slide preset name to change accordingly.

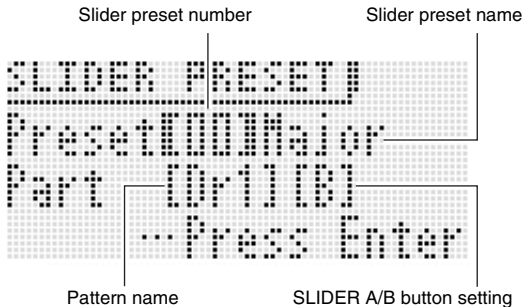

- The following shows the slider preset numbers and their corresponding slider preset names.
  - 1 Major, 2 Minor, 3 Dorian, 4 Lydian,
  - 5 Mixolydn (Mixolydian), 6 Phrygian, 7 Locrian,
  - 8 M.Minor (Melodic Minor), 9 H.Minor (Harmonic Minor),
  - 10 H.M. 5th (Harmonic Minor 5th), 11 Altered (Altered),
  - 12 WholeTon (Whole Tone), 13 Diminish (Diminished),
  - 14 Pentaton (Pentatonic), 15 M.Penta (Minor Pentatonic),
  - 16 Blues, 17 Kick (Bass Drum), 18 Snare, 19 Hi-hat,
  - 20 Toms, 21 Cymbal, 22 Velocity
- The following are the chord part only slider preset numbers and their slider preset names.
  - 1 Diatonic, 2 Minor, 3 H.Minor (Harmonic Minor), 4 Velocity

### ■ Note Shift: Shifts notes.

Use the **17** cursor (<, ^, v, >) buttons to move the brackets [ ] to an item and then use the **17** minus (-) and plus (+) buttons to change the item's shift value setting.

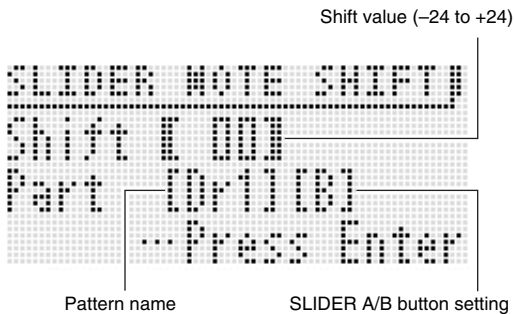

## To save an edited sequence

Press **7** WRITE to display the screen for saving a sequence. Save the sequence by performing the same operation as that for saving a user tone (page E-12).

- For information about deleting data you saved, see page E-83.

### ■ Saving Sequences to an External Device

- Memory card (page E-86)
- Computer (page E-92)

## Chaining

### To create a chain

- In the Step Sequencer Mode, press **10** CHAIN.



- Press **7** EDIT.

- Use the **17** cursor (<, ^, v, >) buttons to move the cursor to an item and then input the setting you want.

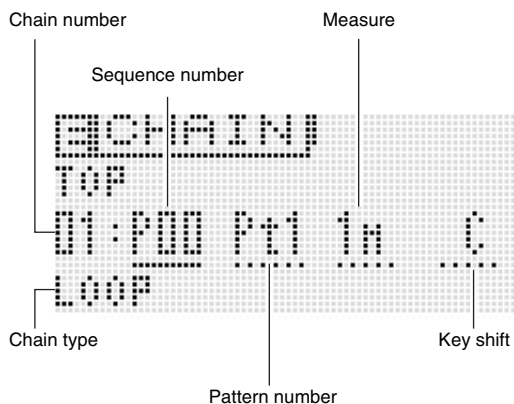

- Button operations to change a setting depend on the item that is selected.
  - Sequence number: To select a sequence, perform steps 2 through 5 under “To use the Arpeggio Function” (page E-40).
  - Pattern number : **17** (-, +) or **11** PATTERN
  - Measure : **17** (-, +)
  - Key shift : **17** (-, +) or keyboard key (leftmost keys, one octave from C to B)
  - Chain type : **17** (-, +)
- For the chain type, you can specify LOOP, which loops playback, or END to end chain playback.
- You can use **10** DELETE to delete part of a chain.
- You also can insert part of a chain by pressing **10** INSERT.
- To check the currently selected pattern, press **10** CHAIN and the press **10** START/STOP to play the pattern. You can edit a pattern as it is playing.

- Press **7** WRITE to display the screen for saving a chain. Save the chain by performing the same operation as that for saving a user tone (page E-12).

- For information about deleting data you saved, see page E-83.

#### ■ Saving a Chain to an External Device

- Memory card (page E-86)
- Computer (page E-92)

#### To play back a chain

- Hold down **10** CHAIN until the CHAIN screen appears.
- Use the **15** dial, **16** buttons, or the **17** minus (-) and plus (+) buttons to display the chain you want to play.



- Press **10** START/STOP.

- To stop playback, press **10** START/STOP again.
- You can rearrange a chain later, if you want. For details about how, see “To create a chain” on page E-61.

#### To initialize chain settings

- Hold down **10** CHAIN until the CHAIN screen appears.
- Press **17** MENU.
- Use the **15** dial or **17** cursor (<, ^, v, >) buttons to move the item selection cursor (●) to “Initialize” and then press **17** ENTER.



- Press **17** ENTER again.

This should cause “Sure?” to appear on the display.

- Press **17** YES.

The message “Complete!” will appear on the display when initialization is complete.



## To save a chain in SMF format to a memory card

- Before performing the following procedure, insert a memory card into the Synthesizer.

1. Hold down **10** CHAIN until the CHAIN screen appears.
2. Use the **15** dial, **16** buttons, or the **17** minus (-) and plus (+) buttons to display the chain you want to save.
3. Press **17** MENU.
4. Use the **15** dial or **17** cursor (<, ^, v, >) buttons to move the item selection cursor (●) to “SMF Save” and then press **17** ENTER.



- For the remainder procedure, perform the steps starting from step 4 under “Saving Synthesizer Data to a Memory Card” (page E-88)

### NOTE

- To save data to a memory card, see “Using a Memory Card” on page E-86.



# Recording and Playing Back with the Sample Looper

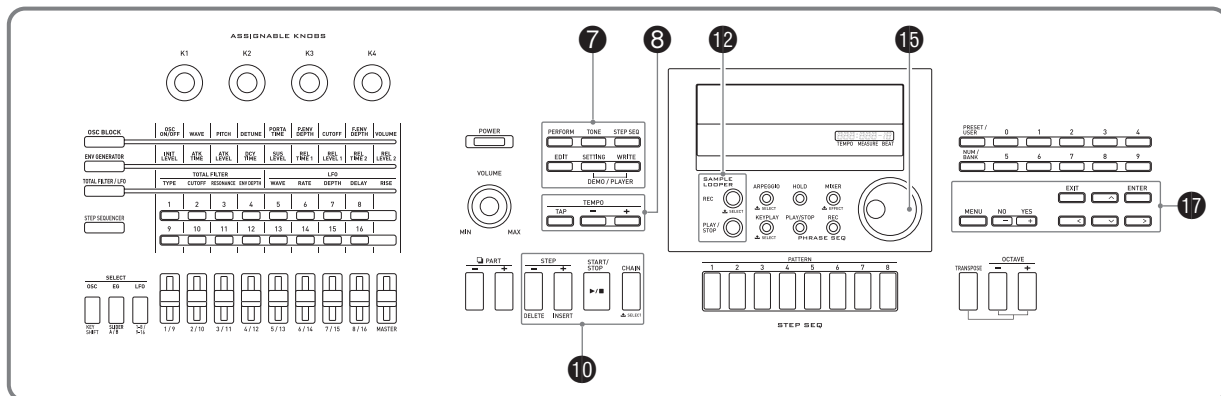

You can use the sample looper to record and loop up to 19 seconds of input from Synthesizer play, a microphone, or line, and to overdub a previously recorded loop. You can store up to 10 samples of recorded data in Synthesizer memory.

- External input to the **21 INST IN** and **21 MIC IN** terminals can be recorded as a sample. Note that input via the **21 AUDIO IN** cannot be recorded as a sample.
- To import a sample to the Synthesizer that is higher quality than external input, use the Data Editor application software (page E-93) to transfer wave data from a computer.

## Sample Recording

- Sample recording can be performed using one of five different Rec Modes, which represent different combinations of start methods and recording types. For details, see “To record with the sample looper” (page E-64).
- User wave editing can be used to edit parameters of a saved sample. See “Editable Parameters for User Wave Tone” (page E-32) for more information.
- A sample can be played back as sample looper data or as a user wave tone on the keyboard.
- LOOP and HOLD settings can be turned on and off for playback of samples, the same as for phrases (page E-45).

## To record with the sample looper

- If you want to input sound from an external source, connect the external source to the Synthesizer as shown on page E-8.
- You can use the Synthesizer’s pedal to perform sample recording and playback operations. For details about configuring pedal settings, see “Pedal” under “Editable Performance Parameter List” (page E-73).

### 1. Press **12 REC**.

This displays the LOOPER REC (sample looper recording) setting screen. For details about the Rec Mode, see step 2 of this procedure.



### ■ Rec Menu Settings

While the LOOPER REC screen is displayed, press **17 MENU** to enter the Rec Menu.



- Use the **17 cursor** (**<**, **^**, **v**, **>**) buttons to select a menu item and then use the **15 dial** or the **17 minus (-) and plus (+) buttons** to change the setting of the item.

Menu	Description	Settings
Precount	Precount (precount). Specifies the precount inserted before recording starts when the record start method is manual mode (ML).	Off, 2 to 8
Threshold	Threshold level (Threshold). Specifies the threshold level that must be exceeded by the input sound to start recording when the record start method is auto mode (AT). • Setting a large value will require a loud sound to start recording.	0 to 127
Reverse	Reverse mode (Reverse). For a new recording, plays back only the first recorded part in reverse.	Off, On
Channel	Sampling channel (Channel). For a new recording, specifies either stereo recording or mono recording.	Stereo: Stereo recording Mono: Monaural recording
Smpl Rate	New recording sampling rate (sampling rate). Sampling frequency.	42 kHz, 21 kHz
Auto OVDB	Specifies the operation after the end point of a sample is set during a new recording. Options are automatic start of loop playback (Off) or overdubbing (On).	Off, On

- Reverse mode, sampling channel, and sampling rate settings are applied only to a new recording. They are not applied during overdubbing.
- The higher the sampling rate, the closer the sample is to the original sound. Allowable recording time depends on the sampling rate and channel settings.

Channel/Rate	Approximate Maximum Recording Time	Maximum Recordable Beats for Each Tempo					
		Tempo 30	Tempo 101	Tempo 120	Tempo 126	Tempo 132	Tempo 255
Stereo/42 kHz	4 seconds	2	8	9	10	10	20
Stereo/21 kHz Mono/42 kHz	9 seconds	4	16	19	20	21	–
Mono/21 kHz	19 seconds	9	32	–	–	–	–

- You can check the current threshold level and input sound level on the screen when configuring the threshold setting.

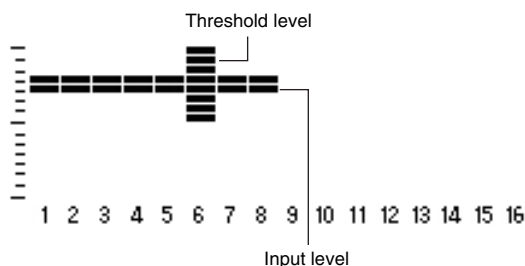

### ■ Adjusting the tempo

Use the **8 TEMPO minus (-) and plus (+) buttons** to adjust the tempo.

- For information about the tempo adjustment method, see “To change the tempo setting” (page E-46).

## 2. Use the **15 dial** and **17 minus (-) and plus (+) buttons** to select one of the five Rec Modes described below.

- The two letters at the end of the mode name indicate the method used to start recording.

AT: Auto. The Synthesizer enters record standby and starts recording automatically when sound is input by playing on the keyboard, with the microphone, etc.

ML: Manual. Recording must be started manually.

- To configure the settings (Length, Beats, Splits) in each Rec Mode, use the **17 up (^) and down (v) buttons** to select an item and then use the **15 dial** or **17 minus (-) and plus (+) buttons** to change the setting.

**(1) NORM-AT:**

Records a new sample with auto start.

- Length (recording time) setting
  - Free : End of the sample is the point where **REC** or **PLAY/STOP** is pressed to stop recording. If the recording reaches the maximum allowable recording time before a button is pressed to stop it, that point becomes the end of the sample.
  - 01 - 32bt : Specifies recording time as a number of beats.



**(2) NORM-ML:**

Records a new sample with manual start.

- The settings for this mode are the same as those for NORM-AT.



**(3) BEAT-AT:**

Creates a sample by recording one beat and repeating it a specified number of times. Only auto recording is available for this mode.

- Beats (number of beats) setting
  - 02 - 32: Specifies the number of times a one-beat recording is repeated.



**(4) SPLT-AT:**

Creates a sample by linking together recordings of a specified number of samples, each of which is a specified length. Only auto recording is available for this mode.

- Length (split length) setting
  - Free : The end of the sample is when there is silence.
  - 1 - 6bt : Specifies the number of beats to elapse before silence, at which time recording of the next split starts. If there is silence before the specified number of beats is reached, recording continues until the specified number of beats is complete.
- Number of splits (divisions) setting
  - 2, 3, 4, 5: Specifies the number of splits.



**■ Selecting a Split Recorded with SPLT-AT as a User Wave Tone**

- To select the split as a Solo Synthesizer tone: See "PCM Wave" (page E-23).
- To select the split as a PCM drum tone: See "Inst Number" (page E-31).

**(5) OVDB-ML:**

Enables overdubbing of an existing sample from the beginning. Only manual recording is available for this mode. When using this Rec Mode, you need to select the existing sample you want to overdub before you perform step 1 of this procedure.

The Synthesizer will automatically enter the OVDB-ML Rec Mode immediately after you record a sample (if the sample has not been stored yet). If you want to re-record new data in this case, select another Rec Mode other than OVDB-ML.

Existing sample number and name



Sampling channel and rate

- Specifying a length that exceeds the maximum allowable recording time will cause “!” to flash on the display. If this happens, adjust length, sampling channel, sampling rate, tempo, and other settings in accordance with the channel/rate indication described on page E-65.
- Performing the operation in step 3 while an exclamation point (!) is flashing on the display will cause the message “LOOPER: Can’t REC” to appear, indicating that recording cannot be started.

**3. Press the **REC** button so it starts flashing, which indicates record standby.**

**4. Depending on the Rec Mode you selected, perform one of the procedures described below to start recording.**

**■ NORM-AT**

**Play something on the keyboard, input sound from the microphone or connected electronic music instrument, or press **REC** to start recording.**

- The **REC** button will stop flashing and remain lit when recording starts.
- While recording is in progress, you can get a rough idea of how much available memory has been used up by checking the memory usage indicator on the Synthesizer display.

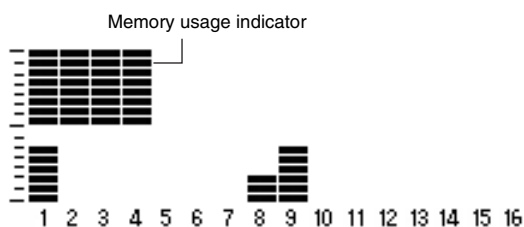

- If you specified a number of beats for the “Length” setting, the **REC** button will start flashing after the specified number of beats is recorded. This indicates that recording is in overdubbing standby.
- If you specified “Free” for the “Length” setting, pressing **REC** during recording to the end of the loop will cause the **REC** button to start flashing. This indicates that recording is in overdubbing standby.
- If the maximum allowable recording time is reached during recording, recording will automatically switch to overdubbing standby.
- As soon as recording enters overdubbing standby, the Synthesizer starts looped playback of the sample as recorded up to that point. During this playback you can rehearse the next part you want to overdub, play a duet with the loop, etc.
- If “Auto OVDB” is turned on, overdubbing will start automatically without entering overdubbing standby.

**■ NORM-ML**

**When you want to start recording, press**

**REC.**

- Once you start recording, procedures are the same as those for NORM-AT.

### ■ BEAT-AT

Play something on the keyboard, input sound from the microphone or connected electronic music instrument, or press **12 REC** to start recording of Beat 1.

- The **12 REC** button will stop flashing and remain lit when recording starts.
- After recording of Beat 1 is complete, the rest of the sample from Beat 2 up to the number of beats specified by the “Beats” setting will be created automatically. After that, recording will enter overdubbing standby.

### ■ SPLT-AT

Play something on the keyboard or input sound from the microphone or connected electronic music instrument and recording will start automatically.

- The **12 REC** button will stop flashing and remain lit when recording starts.
- If you specified something other than “Free” for the “Length” setting, recording will stop after the specified number of beats. When the input sound becomes silent, recording will enter standby for input of the next sound. Recording will restart automatically when an input sound is detected.
- If you specified “Free” for the “Length” setting, recording will pause and standby by for further input sound when the input sound goes silent. Recording will restart automatically when an input sound is detected.
- The input level the Synthesizer uses for auto silence judgment is approximately 0.5 seconds of continual input at a level that half or less the level specified by the Threshold setting (page E-65).  
For example, if the Threshold level is set to 80, approximately 0.5 seconds of continual level of 40 or lower is judged to be silence.
- Recording enters overdubbing standby after the number of recordings specified by the “Splits” setting are complete.

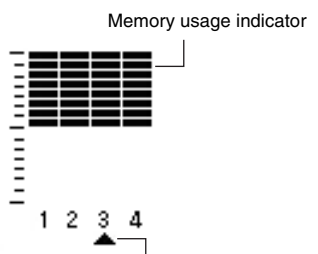

- If you press **12 REC** to stop recording before the number of splits specified by the “Splits” setting, only the number of splits you recorded up to that point will be saved. For example, stopping recording after three splits when 5 is specified for the “Splits” setting will create a loop of three splits.

### ■ OVDB-ML

When using the OVDB-ML Rec Mode, you need to select the existing sample you want to overdub before you perform step 1 of this procedure.

Press **12 REC**.

- This causes **12 REC** to light and starts overdubbing of the sample you selected.
- During overdubbing, the Synthesizer’s display shows the current location of the overdubbing.

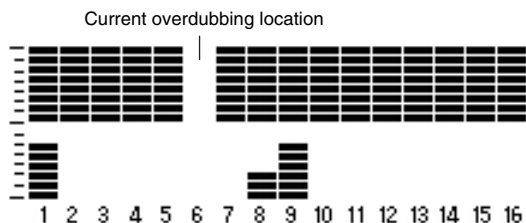

- The **12 REC** button light will go out momentarily to indicate when playback is at the beginning of the sample.
- Overdubbing undo is not possible with the sample looper.

### 5. To restart overdubbing from overdubbing standby, press **12 REC**.

The **12 REC** button will stop flashing and remain lit when overdubbing starts.

- To pause overdubbing, press **12 REC**.
- Though the sample that has been recorded up to that point continues to play as a loop, anything you play while overdubbing is paused is not recorded.
- Press **12 REC** again to resume overdubbing.

### 6. To stop recording, press **12 PLAY/STOP**.

This causes the **12 REC** button light to go out and “!TEMP” (Temporary) to appear on the display for the sample number.

- Even if you stop recording of a sample that contains only silence, it is still treated as a sample.

### 7. After you finish recording, save the data as described below.

- Press **7 WRITE** to display the screen for saving a sample.

## To use the Step Sequencer to record a sample

### 1. Select the Step Sequence you want to use for recording with the sample looper.

- For information about Step Sequencer operation, see “Playing Back a Step Sequence” (page E-52).

### 2. Press **12** REC.

This displays the Rec Mode screen.

- Use the **17** minus (-) and plus (+) keys to change the Rec Mode to NORM-AT.
- Configure the “Length” setting to specify the length of your recording. For example, to specify recording of two measures in 4/4 time, specify 8 for the “Length” setting.

### 3. Press **12** REC again.

This will enter record standby.

### 4. Press **10** START/STOP.

Step sequencer playback and sample recording start simultaneously.

- The **12** REC button will stop flashing and remain lit.
- After recording of the length that corresponds to the “Length” setting you specified in step 2 is complete, recording will enter overdubbing standby. The Step Sequencer will also stop at this time.
- Subsequent operations from this point are the same as those starting from step 4 under “To record with the sample looper” (page E-64).

## To play back a sample

### 1. Hold down **12** REC until the sample selection screen shown below appears on the display.

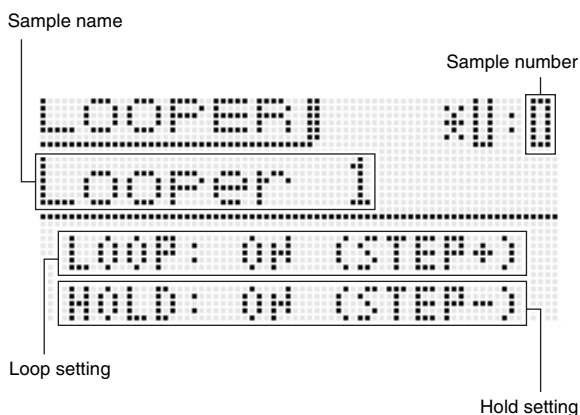

### 2. Select the sample you want to play back.

- The procedure for selecting a sample is the same as step 5 of the procedure for selecting an arpeggio (page E-40).

### 3. Press **10** STEP + to toggle looping between on and off.

OFF: Plays once.

ON : Repeats playback.

- The loop setting cannot be changed if the sample is blank.

### 4. Press **10** STEP - to toggle hold between on and off.

OFF: Playback only while **12** PLAY/STOP is depressed. Playback stops when the button is released.

ON : Playback starts when **12** PLAY/STOP is pressed and stops when **12** PLAY/STOP is pressed again.

- The hold setting cannot be changed if the sample is blank.

**5. Press **12** PLAY/STOP to start sample playback.**

- During playback, a display like the one shown below appears, which lets you determine the current sample playback position.

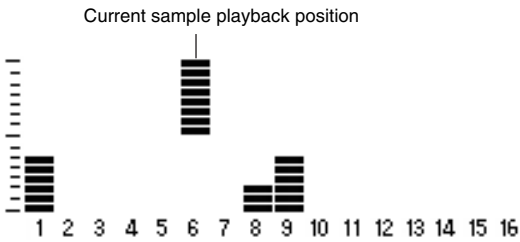

- If you perform playback with the sample selection screen on the display, you can start overdubbing by pressing **12** REC.
- “LOOPER: EMPTY” is indicate on the display when there are no samples available.
- You cannot adjust the tempo during sample playback.

**6. Press **12** PLAY/STOP to stop sample playback.**

**To save a sample**

Press **7** WRITE to display the screen for saving a sample. Save the sample by performing the same operation as that for saving a user tone (page E-12).



- For information about deleting saved data you saved, see page E-83.

**■ Saving a Sample to an External Device**

- Memory card (page E-86)
- Computer (page E-92)

**Indicators Next to Sample Numbers**

The meanings of the indicators that are appended to the sample number on the display are described below.

- ! : Unsaved sample
- \* : Saved sample

!TEMP : Newly recorded sample that has not been saved

- When the currently selected sample has an exclamation mark (!) in front of its sample number or if it has !TEMP instead of a sample number (both indicating it is unsaved), changing the sample selection in step 2 of the procedure under “To play back a sample” (page E-69) will cause the unsaved sample to be discarded. To save an unsaved sample, use the procedure under “To save a sample”, below.



# Using the Performance Mode

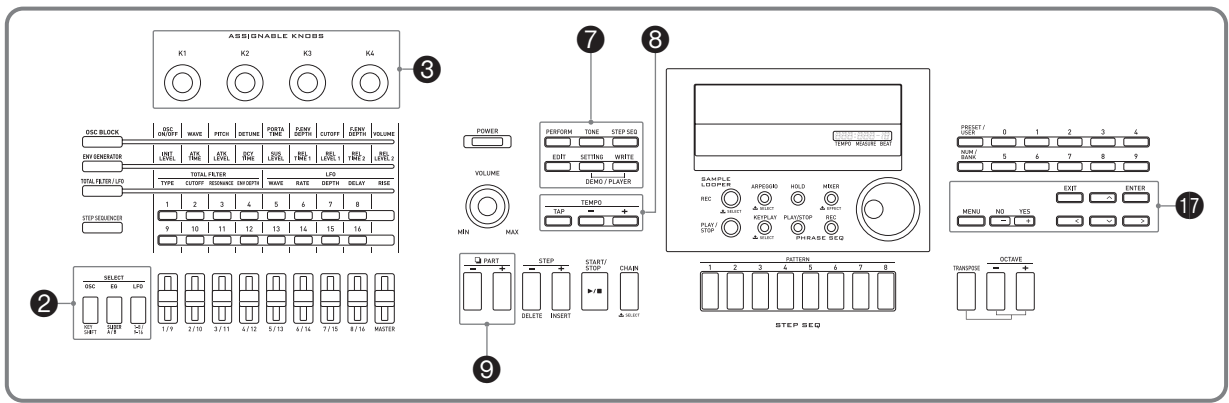

## Overview

You can use the Performance Mode to perform with up to four tones assigned to the keyboard. In addition to tone assignments, you can also save effect, Step Sequencer, and other settings as a setup (called a “performance”) which can be recalled at any time, even while you are playing, to instantly change the sequencer’s setup.

- There are 100 preset performances. You can edit preset performances and save it as one of 100 user performances. See the separate “Appendix” for a list of preset performances.
- A different function can be assigned to each keyboard area and applied whenever keys in its keyboard area is pressed (Multi Function Key). For details about Multi Function Key and about how to configure its settings, see the “Mltfunc Key” item in the “Editable Performance Parameter List” (page E-73).

## Registering and Recalling Performances

### To register a performance

#### 1. Press **7** PERFORM.

The button will light and the Synthesizer will enter the Performance Mode.

Use **17** up (^) / down (v) to select a zone to edit (page E-73).

Zone Param >Phrase Enable (page E-74)

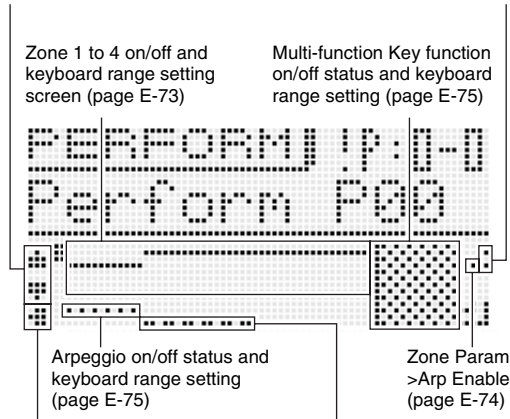

Press **17** left (<) to advance to the screen below.

Phrase key play on/off status and keyboard range setting (page E-75)

#### **3** K1 to K4 knob functions (page E-74)

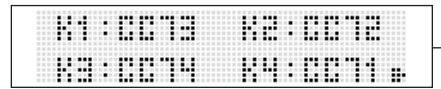

#### 2. Select a performance bank and number using the same procedure as that for selecting an arpeggio (page E-40).

**3. Press **7** EDIT.**

This will display the top screen of the performance editing list.

Zone 1 to 4 on/off and keyboard range settings

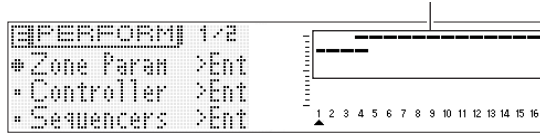

**4. Select items and change settings on the screen using the same procedures as those used when selecting a tone.**

- For details about editing, see “Editable Performance Parameter List” on page E-73.

**5. After you finish with your edits, press **7** EDIT.**

This exits the editing list.

**6. Press **7** WRITE and then save your edited performance as a user performance.**

- For information about how to save user data, see the procedure for saving user tone data (page E-12).

**■ Saving User Performance Data to an External Device**

- Memory card (page E-86)
- Computer (page E-92)

**To recall a performance**

**1. Press **7** PERFORM.**

The button will light and the Synthesizer will enter the Performance Mode.

**2. Select a performance bank and number using the same procedure as that for selecting an arpeggio (page E-40).**

This will recall the contents of the performance you selected.

- Recalled performance contents are the same as those described in “Editable Performance Parameter List” in the next section of this manual.
- Here you can configure a performance filter to omit certain settings (Sequencer, arpeggio, etc.) contained in recalled performance data. Press **17** MENU to display the performance menu. Next, select “PrfrmFilter >Ent” shown below to enter the group and configure performance filter settings.



**Performance Filter Setting List**

Display	Description	Settings
PrfrmFilter >Ent	Performance filter	
Step Seq	Step Sequencer on/off. Turning on this setting filters out Step Sequencer items contained in the Sequencer Parameter group of the Editable Performance Parameter List (page E-73).	Off, On
Arpeggio	Arpeggio on/off. Turning on this setting filters out Arpeggio items contained in the Sequencer Parameter group of the Editable Performance Parameter List (page E-73).	Off, On
Phrase	Phrase on/off. Turning on this setting filters out Phrase Sequencer items contained in the Sequencer Parameter group of the Editable Performance Parameter List (page E-73).	Off, On
Tempo	Tempo on/off. Turning on this setting filters out Tempo settings contained in the Sequencer Parameter group of the Editable Performance Parameter List (page E-73).	Off, On
Sys Rev	System reverb. Turning on this setting filters out reverb items contained in the Effect Parameter group of the Editable Performance Parameter List (page E-73).	Off, On
Sys Cho	System chorus. Turning on this setting filters out chorus items contained in the Effect Parameter group of the Editable Performance Parameter List (page E-73).	Off, On

Display	Description	Settings
Master EQ	Master Equalizer. Turning on this setting filters out master equalizer items contained in the Effect Parameter group of the Editable Performance Parameter List (page E-73).	Off, On
Looper	Sample looper. While this setting is turned on, you will not be able to call up the sample looper items in the Sequencer Parameter group of the Editable Performance Parameter List (page E-73).	Off, On
Multifunc Key	Multi-function Key. While this setting is turned on, you will not be able to call up the sample looper items in the Multi-Function Key Parameter group of the Editable Performance Parameter List (page E-73).	Off, On

## Editable Performance Parameter List

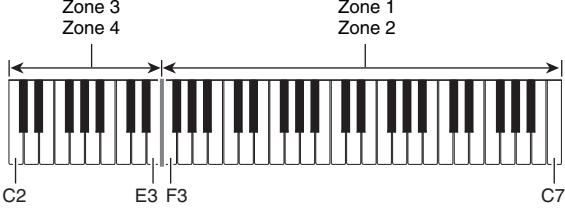

### Editable Parameter List

Display	Description	Settings
Zone Param >Ent	Zone parameters. This group includes parameters for each of the zones (Zone 1 through 4). <ul style="list-style-type: none"> <li>Use the <b>⊖ PART minus (-) and plus (+) buttons</b> to select the zone you want to edit.</li> <li>You also can enter the group using the following shortcut: Perform step 2 under "To register a performance" (page E-71) and then hold down <b>7 EDIT</b>. This will enter the group.</li> </ul>	
Zone	Zone on/off. Turns all zones on or off This setting is different from the mixer function page (page E-80) part on/off (Part Enable) setting.	Off, On
Tone	Tone. Selects the tone for each zone. This setting is the same as the mixer function part tone (page E-80). <ul style="list-style-type: none"> <li>While this item is selected, you can select a tone using the same operation as that used in the Tone Mode.</li> <li>This setting can also be configured using quick editing (page E-16).</li> <li>There are some limitations on the selection of tone categories for Zones 2 through 4 (page E-16).</li> <li>A tone with DSP will have DSP next to the tone name on the display (page E-36).</li> </ul>	Zone 1: Solo Synth P000 to PCM Drum U309 Zone 2 to 4: PCM Tone P100 to PCM Drum U309
KeyRangeLow	Key range low. Specifies the low key range of the keyboard for each zone. This setting is used in combination with the Key Range Hi setting to configure key ranges for each zone.  For example, configuring F3 (low) to C7 (high) for Zones 1 and 2 and C2 (low) to E3 (high) for Zones 3 and 4 will enable play of Zone 1 and 2 tones on the right side keyboard range in the illustration below, and the Zone 3 and 4 tones on the left side keyboard.   <p style="text-align: center;">C2                      E3 F3                      C7</p> <ul style="list-style-type: none"> <li>Setting can be specified using the keyboard keys.</li> </ul>	C- to G9*
KeyRangeHi	Key range high. Specifies the high range of the keyboard for each zone. This setting is used in combination with the Key Range Lo setting to configure key ranges for each zone. <ul style="list-style-type: none"> <li>Setting can be specified using the keyboard keys.</li> </ul>	C- to G9*
Volume	Volume. This setting is the same as the mixer function tone volume (page E-80).	0 to 127
Pan	Pan. Adjusts the left-right position of sound in the stereo field. This setting is the same as the mixer function part panning (page E-80).	-64 to 0 to +63
Oct.Shift	Octave shift. Shifts the tone of notes by octave units.	-2 to 0 to +2
Transpose	Transpose. Shifts the tone of notes by semitone units. This setting is the same as the mixer function part coarse tune (page E-80).	-12 to 0 to +12
FineTune	Fine tune. This setting is the same as the mixer function part fine tune (page E-80).	-99 to 0 to +99
BendRngDwn	Bend range down. Pitch change amount for downward bender operation.	0 to 24
BendRngUp	Bend range up. Pitch change amount for upward bender operation.	0 to 24
Rev Send	Reverb send. This setting is the same as the mixer reverb send (page E-80).	0 to 127
Cho Send	Chorus send. This setting is the same as the mixer chorus send (page E-80).	0 to 127

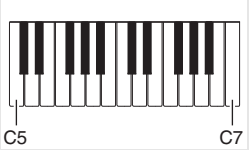
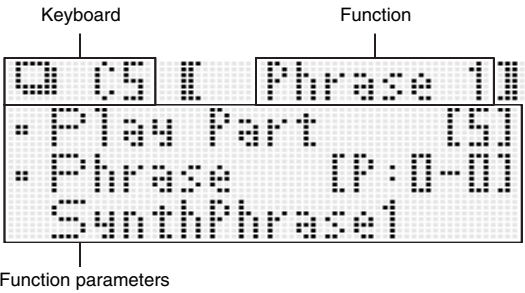
Display	Description	Settings
DSP Line	DSP line. This setting is the same as the mixer function part DSP line (page E-80).	Off, On
Knob1Enable	Knob 1 on/off. Enables/disables <b>3</b> K1 operation for each zone.	Off, On
Knob2Enable	Knob 2 on/off. Enables/disables <b>3</b> K2 operation for each zone.	Off, On
Knob3Enable	Knob 3 on/off. Enables/disables <b>3</b> K3 operation for each zone.	Off, On
Knob4Enable	Knob 4 on/off. Enables/disables <b>3</b> K4 operation for each zone.	Off, On
Bend Enable	Bender on/off. Enables/disables <b>19</b> BENDER operation for each zone.	Off, On
Wheel Enable	Modulation wheel on/off. Enables/disables <b>15</b> MODULATION operation for each zone.	Off, On
Pedal Enable	Pedal on/off. Enables/disables operation of a pedal plugged in to the <b>21</b> SUSTAIN/ASSIGNABLE JACK for each Zone.	Off, On
Arp Enable	Arpeggio on/off. Enables/disables arpeggio function (page E-40) for each zone.	Off, On
Phrase Enable	Phrase on/off. Enables/disables the Phrase Sequencer (page E-45) for each zone.	Off, On
Controller >Ent	Controller parameters. This is group of editable parameters for controller.	
K1	Knob Target 1. Selects the parameter controlled by <b>3</b> K1 knob operation. For example, if "CC67:Soft" is specified for this setting, <b>3</b> K1 operation will apply a soft pedal effect. CC00 to CC97: MIDI control change*1 NRPN, RPN: MIDI NRPN and RPN parameters*1 *2 Ch Pressure: MIDI channel pressure*1 Arpeggio: Preset arpeggio type (page E-40) Tempo: Tempo setting (page E-46) EQ Low Gain - EQ High Gain: Master EQ >Low Gain - High Gain (page E-38)  *1 For details about each setting, refer to the MIDI Implementation document ( <a href="http://world.casio.com/">http://world.casio.com/</a> ) and other MIDI documentation. *2 After selecting these parameters, press <b>17</b> ENTER again and then adjust the items below. MSB: 63H for NRPN, 65H for RPN (Setting range: 000 to 127) LSB: 62H for NRPN, 64H for RPN (Setting range: 000 to 127) Send Data: Specifies whether knob operation controls MSB or LSB. (Settings: MSB, LSB)	Refer to the cell to the left.
K2 to K4	Knob Target 2 to Knob Target 4. As with K1 (Knob Target 1), Selects the parameter controlled by <b>3</b> K2 to K4 knob operation.	Same as K1.
Pedal	Pedal. Specifies the function of the pedal plugged in to <b>21</b> SUSTAIN/ASSIGNABLE JACK. Hold: Pressing the pedal sustains notes. This is a sustain effect. Soft: Pressing the pedal slightly lowers the volume of notes. Sostenuto (Sostenut): Pressing the pedal while keyboard keys are depressed sustains (holds) only the notes of the pressed keyboard keys. Step Sequencer Play/Stop (SSEQ P/S): Pressing the pedal starts or stops Step Sequencer sequence playback. Phrase Sequencer Play/Stop (Phrase P/S): Pressing the pedal starts or stops Phrase Sequencer phrase playback. Phrase Record (Phrase REC): Same function as the Phrase Sequencer <b>14</b> REC button. Sample Looper Play/Stop (Lper P/S): Pressing the pedal starts or stops sample looper sample playback. Sample Looper Record (Lper Rec): Same function as the sample looper <b>12</b> REC button.	Refer to the cell to the left.
Touch	Touch. Specifies touch sensitivity when the keyboard is played. Off (Off): Notes sound at a fixed volume level regardless of keyboard pressure. Normal Light: High-volume notes are easily produced even with light keyboard pressure.	Refer to the cell to the left.
TchOffVel	Touch off velocity. Specifies the volume level when the above touch curve setting values are off.	0 to 127
Sequencers >Ent	Sequencers parameter. This group includes Step Sequencer (page E-50), Phrase Sequencer (page E-45), and Arpeggio function (page E-40).	
Tempo	Tempo. Adjusts the Phrase Sequencer and Step Sequencer playback tempo. You also can change the playback tempo using <b>3</b> TEMPO.	30 to 255
Step SEQ Number	Step sequencer number. Specifies the Step Sequencer sequence (page E-52).	Preset00 to User99
Solo1 Ch	Step Sequencer solo track part. Step Sequencer Solo Track 1 is normally Part 14, but it can be changed to Part 1 (Zone Part 1, page E-55).	1, 14
Change	Step Sequencer change timing. Specifies the switching timing when a pattern is changed by the Step Sequencer (page E-56).	Wait, Real, Beat

Display	Description	Settings
Key Shift	Step Sequencer key shift Switches the Step Sequencer key shift function between on and off (page E-52).	Off, On
Pattern	Step sequencer pattern number. Selects the step sequencer pattern (page E-50).	1 to 8
Arp On/Off	Arpeggio on/off. The arpeggio function is disabled while this setting is off.	Off, On
Arp Type	Arpeggio type. Specifies the arpeggio type (page E-40).	Preset00 to User99
ArpKeyRgLo	Arpeggio key range low. Specifies the low keyboard range where the arpeggio function is enabled. This setting is used in combination with the Arpeggio Key Range Hi setting to configure the keyboard range where the arpeggio function is enabled.	C- to G9*
ArpKeyRgHi	Arpeggio key range high. Specifies the high keyboard range where the arpeggio function is enabled. This setting is used in combination with the Arpeggio Key Range Lo setting to configure the keyboard range where the arpeggio function is enabled.	C- to G9*
Arp Hold	Arpeggio hold on/off. Enables/disables arpeggio hold (page E-40).	Off, On
Arp Synchro	Arpeggio synchronization. Switches the arpeggio sync setting (page E-40).	Off, On, S/S
Key Play	Phrase key play. Turns Phrase Sequencer Phrase key play on or off.	Off, On
Phrase	Phrase number. Selects the phrase of the Phrase Sequencer (page E-45).	Preset00 to User99
PhrKeyRgLo	Phrase key range low. Specifies the low keyboard range where Phrase Sequencer key play is effective (page E-46). This setting is used in combination with the Phrase Key Range Hi setting to specify the keyboard range where key play is enabled.	C- to G9*
PhrKeyRgHi	Phrase key range high. Specifies the effective high keyboard range where Phrase Sequencer key play is effective (page E-46). This setting is used in combination with the Phrase Key Range Lo setting to specify the keyboard range where key play is enabled.	C- to G9*
Looper Number	Looper Number. Uses to select the sample looper sample number (page E-64).	U:0 to U:9
Mltfunc Key >Ent	Multi-function Key. Assigns different functions to each keyboard area ranging from C5 to C7 (up to 25 keys). 	
Enable	Turns Multi-function Key on or off.	Off, On
KeyRangeLow	Low keyboard range of Multi-Function Key (Multi-function Key Range Low). Specifies the lowest keyboard range in which Multi-Function Key is applied. • Setting can be specified using the keyboard keys.	C5 to C7
Key Setting >Ent	Function assigned to a keyboard range (Key Setting). There are two methods for specifying the keyboard range being assigned: playing keys within the range on the keyboard and using the <b>9</b> <b>PART minus (-) and plus (+) buttons</b> . 	
-----	Indicates that the Multi-function Key function is not configured. • Nothing will sound if "Mltfunc Key >Enable" is turned on while the function is not configured.	-
Phrase 1	Phrase 1. Specifies the playback part and performs phrase playback. Can be assigned to keyboard range C5 to B*5. When Phrase 1 is configured, the Phrase 1 Stop operation can be performed with key B5. Part 5 or Part 1 can be selected as the playback part. During playback, the display segment at the top of Part 15 is lit. The key shift value during playback can be specified. • You can display the playback part mixer setting screen by pressing <b>13</b> <b>MIXER</b> . • Playback part mixer settings are saved as a performance.	<ul style="list-style-type: none"> <li>• Play Part: 1, 5</li> <li>• Phrase: P:0-0 to P:9-9, U:0-0 to U:9-9</li> <li>• Key Shift: -127 to 000 to +127</li> </ul>

Display	Description	Settings
Phrase 2	Phrase 2. Specifies the playback part and performs phrase playback. Can be assigned to keyboard range C6 to B <sup>b</sup> 6. When Phrase 2 is configured, the Phrase 2 Stop operation can be performed with key B6. Part 6 or Part 1 can be selected as the playback part. During playback, the display segment at the top of Part 16 is lit. The key shift value during playback can be specified. <ul style="list-style-type: none"> <li>You can display the playback part mixer setting screen by pressing <b>13 MIXER</b>.</li> <li>Playback part mixer settings are saved as a performance.</li> </ul>	<ul style="list-style-type: none"> <li>Play Part: 1, 6</li> <li>Phrase: P:0-0 to P:9-9, U:0-0 to U:9-9</li> <li>Key Shift: -127 to 000 to +127</li> </ul>
Tempo	Tempo. Changes the tempo. When TAP is selected for this setting, the same operations as the TAP button are performed. For other settings are selected, the tempo is changed in accordance with the settings shown in the column to the right.	TAP, +, -, 30 to 255
Tone	Tone. When a keyboard range specified for a tone is pressed, the tone of the specified zone changes in accordance with the Tone content.	<ul style="list-style-type: none"> <li>Zone: 1, 2, 3, 4</li> <li>Tone: Number that can be selected by +, -, or "Zone Param &gt;Tone"</li> </ul>
Step Seq	Step Sequencer. Changes the sequence being played.	+, -, P:0-0 to P:9-9, U:0-0 to U:9-9
Chain	Chain. Switches and turns on chains.	+, -, U:0-0 to U:9-9
DSP	DSP. Switches the DSP. When Off, the Chorus/DSP select (page E-38) setting becomes Chorus. However, DSP cannot be switched while a Solo Synthesizer tone is selected.	Off, +, -, ton, P:0-0 to P:9-9, U:0-0 to U:9-9
DSP Line	DSP Line. Toggles DSP Line Select for the selected part between on and off.	01 to 16
Note	Note. Generates a note in accordance with the specified part number (Part), keyboard key (Key), and velocity (Velocity) settings.	<ul style="list-style-type: none"> <li>Part: 01 to 16</li> <li>Key: C- to G9*</li> <li>Velocity: KeyOn, 001 to 127</li> </ul>
Ctrl Chng	Control change. Generates a control change in accordance with the specified part number (Part), control number (Control), and value (Value). When KeyOn is specified for Value, a key on velocity value is generated. Note, however, that a 000 value is not generated when keyboard keys are released.	<ul style="list-style-type: none"> <li>Part: 01 to 16</li> <li>Control: 000 to 119</li> <li>Value: KeyOn, 000 to 127</li> </ul>
Prog Chng	Program Change with Bank MSB. Generates a program change in accordance with the specified part number (Part), bank MSB (Bank MSB), and value (Value).	<ul style="list-style-type: none"> <li>Part: 01 to 16</li> <li>Bank MSB: 000 to 127</li> <li>Value: 000 to 127</li> </ul>
Ch Press	Channel Pressure. Generates channel pressure in accordance with the specified part number (Part) and value (Value). Channel after touch. Generates a 000 value when keyboard keys are released.	<ul style="list-style-type: none"> <li>Part: 01 to 16</li> <li>Value: KeyOn, 001 to 127</li> </ul>
Pitch Bend	Pitch bender. Generates pitch bender in accordance with the specified part number (Part) and value (Value). Generates a 000 value when keyboard keys are released.	<ul style="list-style-type: none"> <li>Part: 01 to 16</li> <li>Value: KeyOn, -256 to 000 to 255</li> </ul>
Poly Press	Polyphonic Key Pressure. Generates polyphonic key pressure in accordance with the specified part number (Part), keyboard key (Key), and value (Value). Generates a 000 value when keyboard keys are released. <ul style="list-style-type: none"> <li>Setting can be specified using the keyboard keys.</li> </ul>	<ul style="list-style-type: none"> <li>Part: 01 to 16</li> <li>Key: C- to G9*</li> <li>Value: KeyOn, 001 to 127</li> </ul>
Effect >Ent	Effect parameter. This group includes effect settings (page E-37). For details about group items, see "Effect Settings" (page E-38).	
MIDI >Ent	MIDI parameters. This group includes MIDI parameter (page E-82) settings. Use the <b>9 PART minus (-) and plus (+) buttons</b> to select one of the Synthesizer's 16 sound source parts for editing.	
Ext Out Ch	External Out Channel. Specifies the MIDI send channel for sending information about each part to an external destination (page E-82).	1 to 16
Ext In Ch	External in channel. This is the MIDI message channel received by each part.	Off, 1 to 16
Gen Out	Internal send on/off. Specifies whether or not the information of each part is sent to the Synthesizer's sound source.	Off, On

Display	Description	Settings
MIDI Out	MIDI output on/off. Specifies whether or not MIDI send of the information of each part is performed from  <b>MIDI OUT/THRU</b> .	Off, On
USB Out	USB output on/off. Specifies whether or not MIDI send of the information of each part is performed from  <b>USB</b> .	Off, On

\* "C-" on the display indicates C-1 (one octave below C0).

# Other Useful Functions

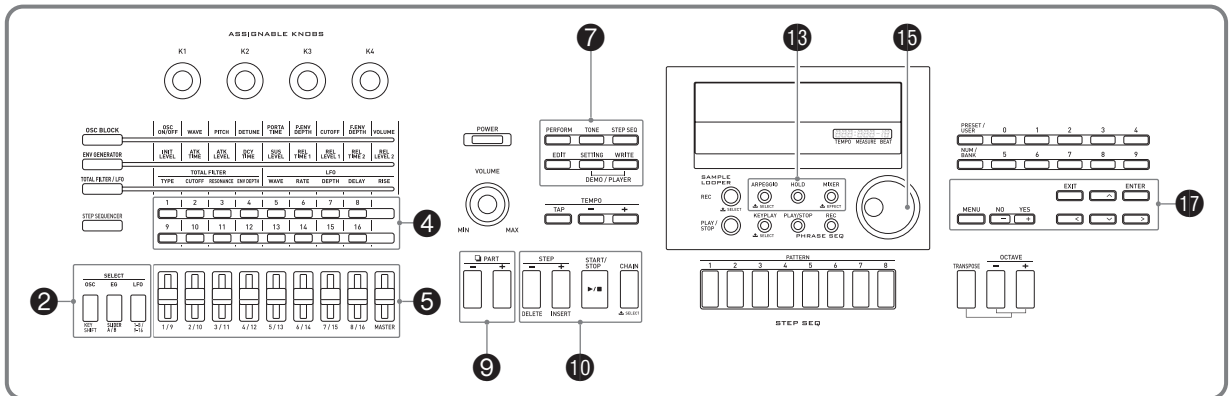

## Using the Mixer

The mixer lets you make adjustments to the tone, volume level, and other settings\* of the Synthesizer's sound source parts (Parts 01 through 16, external input parts, page E-18), while viewing the balance between the parts on the display.

\* Settings that affect individual parts are called "part settings", while settings that affect all parts are called "master settings".

### 1. Press **13** MIXER.

This displays the mixer screen.

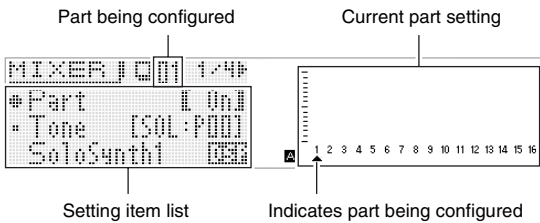

### 2. Use the **9** PART minus (-) and plus (+) buttons to select the part whose settings you want to configure.

To perform this adjustment:	Select this part:
Individual settings (page E-80) of parts 01 through 16	All, 01 to 16 • "All" can be selected to batch adjust all parts from 01 through 16. To select "All", press the <b>9</b> PART minus (-) button once while "01" is displayed.
Master settings (page E-80)	Master • To select "Master", press the <b>9</b> PART minus (-) button twice while "01" is displayed.
External input part settings (page E-80)	Ext • To select "Ext", press the <b>9</b> PART minus (-) button three times while "01" is displayed.

### 3. Use the **17** cursor (<, ^, v, >) buttons to select the item you want, and then use the **15** dial or **17** minus (-) and plus (+) buttons to change its setting.

- For details about settings, see "Mixer Settings" on page E-80

### 4. After settings are the way you want, press **13** MIXER to exit the mixer screen.



## Instant Adjustment of Settings using the Sliders and Step Buttons

You can use the **5** 1/9 to MASTER sliders and the **4** step (1 to 16) buttons to make instant changes in mixer settings.

### 1. Press **13** MIXER.

This displays the mixer screen.

### 2. Use the **2** KEY SHIFT, SLIDER A/B, and 1-8/9-16 buttons to change the part assigned to the **5** 1/9 to MASTER sliders.

- Each press of one of the above buttons toggles the button between being lit and unlit.

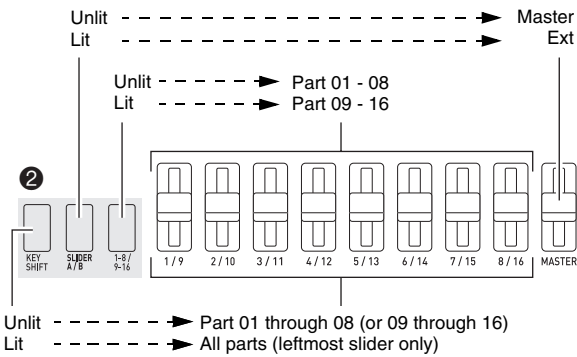

### 3. Move a slider to adjust the setting of the part assigned to it.

- Use the **17** cursor (<, ^, v, >) buttons to select a setting item.

### 4. Use the **4** 1 to 16 buttons to toggle parts 01 through 16 between on and off.

- Each press of a button toggles it between lit (on) and unlit (off).
- Holding a button down will turn that part on and turn all other parts off (solo mode). Press the same button again to exit the solo mode.

Example: To enter the solo mode for Part 08

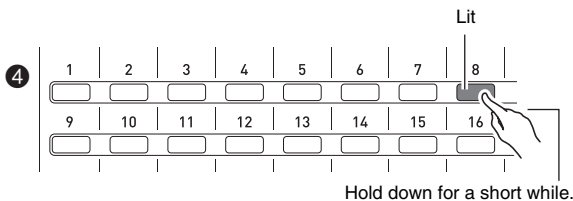

## Mixer Settings

### ■ Part 01 through Part 16 Settings

Display	Description	Settings
Part	Part on/off. Turns each part on or off. This is the same parameter that is turned on and off by the <b>4</b> <b>1 to 16 buttons</b> (page E-79).	Off, On
Tone	Part tone. This is the tone of each part. While this item is selected, you can select a tone using the same operation as that used in the Tone Mode. • A tone with DSP will have DSP next to the tone name on the display (page E-37).	Part 01: Solo Synth P000 to PCM Drum U309 Part 02 to 16: PCM Tone P100 to PCM Drum U309
Volume	Part volume. This is the volume of each part.	0 to 127
Pan	Part panning. Adjusts the left-right position of sound in the stereo field.	-64 to 0 to +63
CoarseTune	Part coarse tune. Shifts the pitch of notes by semitone units.	-12 to 0 to +12
FineTune	Part fine tune. Shifts the pitch of notes by cent units.	-99 to 0 to +99
BendRange	Part bend range. Specifies (in semitone units) the maximum change in pitch when the <b>19 BENDER</b> wheel is rotated.	-24 to 0 to +24
DSP Line	Part DSP line. Specifies whether DSP (page E-36) is applied to the notes of each part.	Off, On
Rev Send	Part reverb send. Controls how the reverb effect (page E-36) is applied to each part.	0 to 127
Cho Send	Part chorus send. Controls how the chorus effect (page E-36) is applied to each part.	0 to 127

### ■ External Input Part Settings

Display	Description	Settings
Part	Same as "Part 01 through Part 16 Settings" (page E-80).	
Volume		
Pan		
DSP Line		
Rev Send		
Cho Send		
N.Thresh	Noise gate threshold. Reduces noise by cutting all input sound at a volume that is smaller than this setting value.	0 to 127
N.Release	Noise gate release. Time that input sound is cut after its volume drops below the noise gate threshold value.	0 to 127
Auto Level	Auto level control. Automatically adjusts the input signal level. The greater the setting value, the stronger the effect.	Off, 1 to 3

### ■ Master Settings

Display	Description	Settings
Volume	Master volume. Adjusts the volume of all the parts.	0 to 127
Pan	Master panning. Adjusts the left-right position of sound in the stereo field of all the parts.	-64 to 0 to +63

## Global Synthesizer Settings

The following are Synthesizer settings that can be configured globally.

- Tuning (Fine tuning of note pitch)
- Local Control
- Master Coarse Tune (Tuning of note pitch in semitone steps)
- Initial Power On Mode
- Display Contrast
- Auto Power Off On/Off (page E-10)

### 1. Press **7** SETTING.

This displays the setting screen with "General >Ent" selected.



### 2. Press **17** ENTER.



### 3. Use the **17** cursor (<, ^, v, >) buttons to select the item you want, and then use the **15** dial or **17** minus (-) and plus (+) buttons to change its setting.

#### Settings

Display	Description	Settings
Tuning	Tuning. Fine tuning of Synthesizer pitch in 0.1 Hertz steps.	415.5 to 465.9 Hz
M.Coarse	Master coarse tune. Adjustment of overall Synthesizer pitch in semitone units	-24 to 0 to +24
Local Ctrl	Local control. Turning off local control disables the Synthesizer's internal sound source, so nothing sound when keyboard keys are pressed. Turn off local control when you want to use the Synthesizer keyboard and pedal operations to operate an external sound source, without producing any sound from the Synthesizer itself.	Off, On
Start Up	Start up item. Specifies one of the following as the Synthesizers initial power on mode. Perfm: Performance Mode Tone: Tone Mode S.Seq: Step Sequencer Mode	Refer to the cell to the left.
Contrast	Display contrast. Adjusts the contrast of the display.	1 to 17
Auto Power	Auto Power Off function on/off. Turning off this setting disables Auto Power Off (page E-10).	Off, On

### 4. After settings are the way you want, press **7** SETTING to exit the setting screen.

## Using MIDI

### What is MIDI?

The letters MIDI stand for Musical Instrument Digital Interface, which is the name of a worldwide standard for digital signals and connectors that makes it possible to exchange musical data between musical instruments and computers (machines) produced by different manufacturers.

For details about the MIDI specifications of this Synthesizer, see the “MIDI Implementation” document at the website located at the URL below.

<http://world.casio.com/>

#### NOTE

- Use a separately available or commercially available MIDI cable to connect the MIDI terminals of your Synthesizer and another electronic musical instrument for exchange of MIDI data (page E-8).
- For information about connecting a computer, see page E-92.
- For information about the relationship between each Synthesizer part (page E-78) and the MIDI IN and MIDI OUT channels, see “Editable Performance Parameter List” (page E-73).
- This Synthesizer conforms to General MIDI Level 1 (GM).

### MIDI Settings

1. Press **7** SETTING.
2. Use the **17** down (∨) button to select “MIDI >Ent” and then press **17** ENTER.
3. Use the **17** cursor (<, ^, ∨, >) buttons to select the item you want, and then use the **15** dial or **17** minus (-) and plus (+) buttons to change its setting.

#### Settings

Display	Description	Settings
Device ID	Device ID. Selects the ID number of the Synthesizer for MIDI system exclusive message send/receive. • While “All” is selected, a system exclusive message is sent regardless of the ID number. • For details about the ID number, see MIDI Implementation at <a href="http://world.casio.com/">http://world.casio.com/</a> .	1 to 16, ALL
Basic Ch	Basic channel. Specifies the receive channel of “Perform NRPN”, “S.Seq NRPN”, and other MIDI messages described below.	1 to 16
MIDIOutSel	MIDI OUT select. Specifies what is output as MIDI OUT.* KEY (Keyboard): Synthesizer keyboard play, operations, etc. MIDI (MIDI IN): Messages input via <b>20</b> MIDI IN (MIDI THRU) USB (USB IN): Messages input via <b>20</b> USB	Refer to the cell to the left.
USBOutSel	USB out select. Specifies what is output as USB out.* KEY (Keyboard): Keyboard and other Synthesizer operations MIDI (MIDI IN): Messages input via <b>20</b> MIDI IN	Refer to the cell to the left.
MIDI In	MIDI IN on/off (MIDI IN enable). While this setting is turned on, messages input via <b>20</b> MIDI IN are reflected by the Synthesizer’s internal sound source.	Off, On
USB In	USB IN on/off (USB IN enable). While this setting is turned on, messages input via <b>20</b> USB are reflected by the Synthesizer’s internal sound source.	Off, On
Sync Mode	Sync mode. Settings for MIDI syncing between the Synthesizer and an external device.* Off: No syncing Mast (Master): Outputs Clock, Start/Stop (Step Sequencer), and other signals from the Sequencer to control an external device. Slav (Slave): Receives Clock, Start/Stop, and other signals from an external device. • Step Sequencer and Phrase Sequencer playback is not possible unless Clock is received. Start/Stop is interpreted as Step Sequencer start/stop.	Refer to the cell to the left.
Perform NRPN	Performance NRPN change. When this setting is turned on, a Synthesizer performance (page E-72) can be selected by a MIDI NRPN message from an external device.	Off, On
S.Seq NRPN	Step Sequencer NRPN change. When this setting is turned on, a Synthesizer sequence (page E-52) can be selected by a MIDI NRPN message from an external device.	Off, On
Phrase NRPN	Phrase NRPN change. When this setting is turned on, a Synthesizer phrase (page E-45) can be selected by a MIDI NRPN message from an external device.	Off, On

Display	Description	Settings
Arp NRPN	Arpeggio NRPN change. When this setting is turned on, a Synthesizer arpeggio type (page E-40) can be selected by a MIDI NRPN message from an external device.	Off, On

\* To apply setting changes, turn the Synthesizer off and then back on again. A message to that effect appears on the display whenever you exit a setting screen.

**4. After settings are the way you want, press **7** SETTING to exit the setting screen.**

#### **NOTE**

- You can also use performance data editing to change the MIDI data send channel and configure other settings. For more information, see the “MIDI >Ent” group (page E-76).

## Deleting Data Saved on the Synthesizer

You can use the procedure below to delete user tones, user sequences, and other data that you created.

**1. Referring to the table in step 2 of the procedure under “To save Synthesizer data to a memory card” (page E-88), perform the procedure required for the type of data you want to delete.**

**2. Use the **17** up (**^**) and down (**∨**) buttons to move the item selection cursor (**●**) to “Clear USER” and then press **17** ENTER.**

- This causes a menu screen like the one shown below to appear on the display. The sample screen below shows the screen that appears when you perform this procedure from the Step Sequencer Mode.

- In the case of the Phrase Sequencer, the phrase data size is also displayed.

**3. Use the **15** dial or **17** minus (**-**) and plus (**+**) buttons to select the user data you want to delete.**

**4. Press the **17** ENTER button.**

**5. In response to the “Sure?” message that appears, press the **17** YES button to delete or the **17** NO button to cancel.**

## Initializing Synthesizer Global Settings and Data

You can use the procedure below to return the Synthesizer's settings and data to their initial defaults.

1. Press **7** SETTING.
2. Press **17** ENTER.
3. Use the **17** cursor (<, ^, v, >) buttons to select "Initialize >Ent" and then press **17** (ENTER).

This will display the INITIALIZE screen.



4. Use the **17** up (^) and down (v) buttons to select the initialization option you want.

### Initialization Options

Display	Description
Parameter >Ent	Parameters only. Initializes all Synthesizer settings except for display contrast (E-81).
All >Ent	All settings and data. Returns all Synthesizer settings and data to their initial defaults. Also deletes user waves.

5. Press **17** ENTER.  
This should cause "Sure?" to appear on the display.
6. Press **17** YES.  
The message "Complete!" will appear on the display when delete is complete.
7. Press **7** SETTING to exit the setting screen.
  - You can visit the CASIO website (<http://world.casio.com/>) to download the Synthesizer's factory default settings and data, and transfer it to the Synthesizer, if you want.  
To connect to a computer, see "Connecting to a Computer" (page E-92).

## Playing a Demo Tune or a File from a Memory Card

You can use the procedure below to play back the Synthesizer built in demo tunes, and to play back SMF (Standard MIDI File) music files on a memory card.

1. Press **7** SETTING and **7** WRITE at the same time.



2. Use the **17** up (^) and down (v) buttons to select the type of playback you want to perform.

### Auto Playback Types

Display	Description
Demo >Ent	Demo Tune (Demo). For playback of the Synthesizer's built-in demo tunes.
Smf >Ent	SMF (Standard MIDI File) music files. For playback of SMF music files from a memory card loaded in the Synthesizer's card slot. <ul style="list-style-type: none"> <li>Supported playback music files formats are SMF format 0 and 1 MIDI files (MID).</li> <li>Make sure that the data you want to play is in the MUSICDAT folder (page E-89) on the memory card.</li> </ul>

### 3. Press **17** ENTER.

This displays the playback screen.

- In the case of a demo tune, playback will start automatically. In the case of an SMF music file, use the **17** minus (-) and plus (+) buttons to select a file and press **10** START/STOP to start playback.
- While playback is in progress, you can use the **15** dial or **17** minus (-) and plus (+) buttons to change to a different tune or file for playback.  
You also can use the four **10** buttons to perform fast forward and other playback operations as shown below.

Demo Tune Playback Screen



Operation Guide

- ◀◀ (Fast Reverse) : **10** STEP -
- ▶▶ (Fast Forward) : **10** STEP +
- (Stop) : **10** START/STOP
- ▮ (Pause) : **10** CHAIN

### 4. Press **10** START/STOP.

This stops playback and exits the playback screen.

- You also can stop playback by pressing the **7** SETTING and WRITE buttons at the same time or by pressing **17** EXIT.

# Using a Memory Card

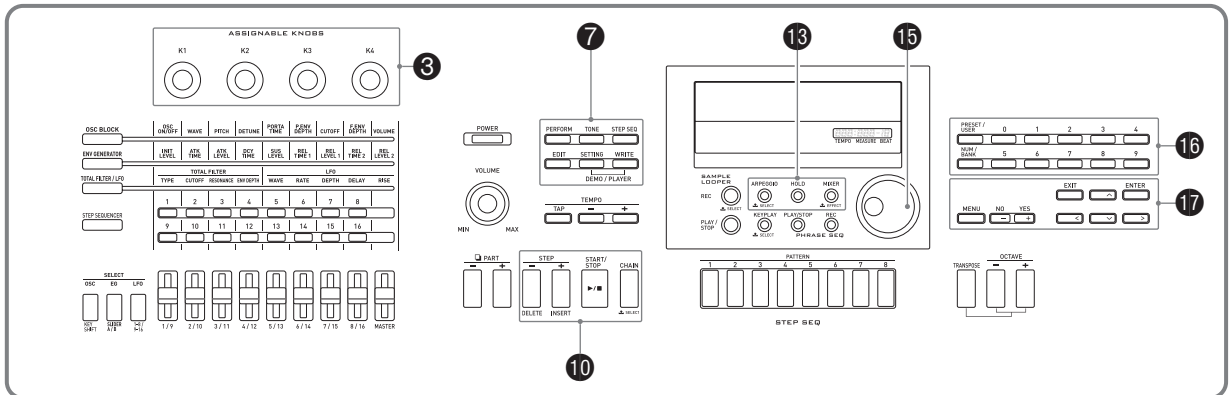

You can save Synthesizer user area data to a memory card and load data from a memory card to Synthesizer memory. You also can play music files (MIDI files) stored on a memory card on the Synthesizer.

## IMPORTANT!

- Use a memory card that satisfies the conditions below.

**Format: SDHC or SD**

**Capacity: 32GB or less**

**Use of any memory cards other than those defined above is not supported.**

- SDHC Logo is a trademark of SD-3C, LLC.



Data Type	Description (File Name Extension)
User arpeggios (page E-41)	Arpeggio data edited with the Synthesizer (ZAR)
All data	All of the above data (ZAL)
Setting data	Setting data configure with the Synthesizer (ZST)

- For information about saving and importing individual data items, see “Saving Synthesizer Data to a Memory Card” (page E-88) and “Loading Data from a Memory Card” (page E-90).
- For details about saving and loading all data, see “To batch save all Synthesizer data to a memory card” (page E-89) and “To batch load all Synthesizer memory data from a memory card” (page E-90).

## Supported Data Types

- Data that can be saved to and exported from a memory card

Data Type	Description (File Name Extension)
User performances (page E-71)	Performance data edited with the Synthesizer (ZPF)
User PCM melody tones (page E-30)	Melody tone data edited with the Synthesizer (ZTN)
User Solo Synthesizer tones (page E-21)	Solo Synthesizer tone data edited with the Synthesizer (ZSY)
User PCM drum tones (page E-31)	Drum tone data edited with the Synthesizer (ZDR)
User Wave Tone (page E-32)	User wave tone data edited with the Synthesizer (ZWT)
User DSP data (page E-39)	DSP data edited with the Synthesizer (DS7)
User step sequences (page E-61)	Step sequence data recorded with the Synthesizer (ZSS)
Step sequence chains (page E-62)	Sequence chain data recorded with the Synthesizer (ZSC, MID (save only))
User phrases (page E-49)	Phrase data recorded with the Synthesizer (ZPH)

- Data that can be directly played back from a memory card

Data Type	Description (File Name Extension)
Song files (page E-91)	SMF format 0 or 1 MIDI files (MID)

## NOTE

- If you want to use data stored on a memory card that is not supported by this Synthesizer, you need either to copy the data to a memory card supported by the Synthesizer, or use Data Editor to transfer the data from a computer to the Synthesizer. For more information, see “Connecting to a Computer” (page E-92).



## Card and Card Slot Precautions

- Be sure to observe the precautions provided in the documentation that comes with the memory card.
- Memory cards have a write-protect switch. Use it when you want to protect the data on the card from accidental deletion.
- Avoid using a memory card under the following conditions. Such conditions can corrupt data stored on the memory card.
  - Areas subjected to high temperature, high humidity, or corrosive gas.
  - Areas subjected to strong electrostatic charge and digital noise.
- Never touch the contacts of a memory card when loading it or removing it from the Synthesizer.
- The message “Please Wait” will remain on the display while a data save operation is in progress. Do not perform any other operation while it is displayed. Turning off the Synthesizer or removing the memory card can cause Synthesizer data to be deleted or become corrupted. It also can cause the Synthesizer to fail to turn on when **6 POWER** is pressed. If this happens, refer to “Troubleshooting” (page E-95).
- If the message “No Card” appears on the display, it means there is no memory card in the card slot. For details about what appears on the display while a card is loaded, see “Playing a Music File from a Memory Card” (page E-91).
- Never insert anything besides a memory card into the card slot. Doing so creates the risk of malfunction.
- Electrostatic charge from your fingers or the memory card to the card slot can cause malfunction of the Synthesizer. If this happens, turn the Synthesizer off and then back on again.
- A memory card can become quite warm after very long use in the card slot. This is normal and does not indicate malfunction.

## Loading and Removing a Memory Card

### ! IMPORTANT!

- **A memory card must be positioned correctly when being loaded into the Synthesizer. Trying to force an improperly oriented memory card into the slot can damage the memory card and the slot.**

- 1. With the top of the memory card facing upwards (so you can see it), carefully insert it into the Synthesizer’s SD card slot (20) until stops with a click.**

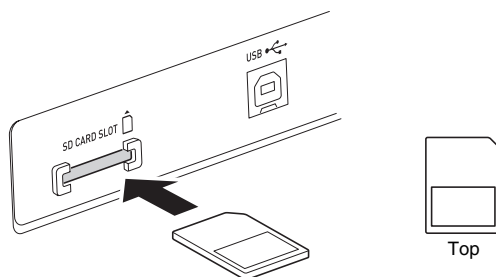

- 2. To remove the memory card first press it into the slot further.**

- This will cause the memory card to disengage and eject partially. Pull the memory card the rest of the way out of the slot.

## Formatting a Memory Card

### IMPORTANT!

- Format a memory card before using it for the first time.
- Before formatting a memory card, make sure it does not have any valuable data stored on it.
- The memory card format operation performed by this Synthesizer is a “quick format”. If you want to completely delete all of the data on the memory card, format it on your computer or some other device.

#### 1. Insert the memory card you want to format into the Synthesizer’s card slot.

- Make sure the memory card is write-enabled. Check the position of the card’s write-protect switch to ensure it is not in the write-protect position.

#### 2. Press **7** SETTING.

#### 3. Use the **17** up (**^**) and down (**v**) buttons to move the item selection cursor (**●**) to “CardUtility” and then press **17** ENTER.

- This causes the “CARD UTIL” screen to appear.

#### 4. Use the **17** up (**^**) and down (**v**) buttons to move the item selection cursor (**●**) to “Format”.

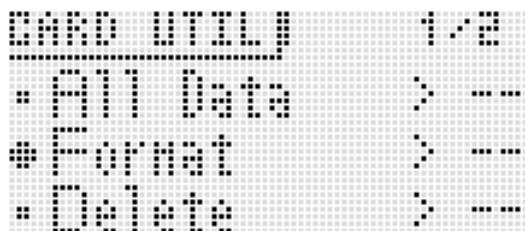

#### 5. Press the **17** ENTER button.

- This will cause the confirmation message “Sure?” to appear.

#### 6. Press the **17** YES button to format the memory card or the **17** NO button to cancel.

- The message “Please Wait” will remain on the display while the format operation is being performed. Do not perform any Synthesizer operation while this message is on the display. “Complete!” appears on the display after formatting is complete.
- Formatting may take as long as a few minutes to complete.

## Saving Synthesizer Data to a Memory Card

### To save Synthesizer data to a memory card

1. Insert the memory card into the card slot.
2. Depending on the type of data you want to save to the memory card, perform one of the steps shown below.

To save this type of data:	Perform these steps:
One user performance	1. Press <b>7</b> PERFORM. 2. Press <b>17</b> MENU.
One user tone (User Solo Synthesizer tone, user PCM melody tone, user PCM drum tone, user wave tone)	1. Press <b>7</b> TONE. 2. Use the <b>15</b> dial or <b>16</b> number buttons to select a tone. 3. Press <b>17</b> MENU.
One user wave	1. Hold down <b>12</b> REC until “LOOPER” appears on the display. 2. Press <b>17</b> MENU.
One user DSP	1. Hold down <b>13</b> MIXER until the EFFECT screen appears on the display. 2. Use the <b>17</b> cursor ( <b>&lt;</b> , <b>^</b> , <b>v</b> , <b>&gt;</b> ) buttons to move the item selection cursor ( <b>●</b> ) to “DSP Select” and then press <b>17</b> ENTER. • “Ent” is not displayed in the case of a Solo Synthesizer tone. 3. Press <b>17</b> MENU.
One user step sequence	1. Press <b>7</b> STEP SEQ. 2. Press <b>17</b> MENU.
One step sequence chain	1. Hold down <b>10</b> CHAIN until the CHAIN screen appears on the display. 2. Press <b>17</b> MENU.
One user phrase	1. Hold down <b>14</b> KEY PLAY until the PHRASE screen appears on the display. 2. Press <b>17</b> MENU.
One user arpeggio	1. Hold down <b>13</b> ARPEGGIO until the ARPEGGIO screen appears on the display. 2. Press <b>17</b> MENU.
All data	1. Press <b>7</b> SETTING. 2. Use the <b>17</b> up ( <b>^</b> ) and down ( <b>v</b> ) buttons to move the item selection cursor ( <b>●</b> ) to “CardUtility” and then press <b>17</b> ENTER. 3. Use the <b>17</b> up ( <b>^</b> ) and down ( <b>v</b> ) buttons to move the item selection cursor ( <b>●</b> ) to “All data” and then press <b>17</b> ENTER.
Setting data	1. Press <b>7</b> SETTING. 2. Use the <b>17</b> up ( <b>^</b> ) and down ( <b>v</b> ) buttons to move the item selection cursor ( <b>●</b> ) to “CardUtility” and then press <b>17</b> ENTER. 3. Use the <b>17</b> up ( <b>^</b> ) and down ( <b>v</b> ) buttons to move the item selection cursor ( <b>●</b> ) to “SettingData” and then press <b>17</b> ENTER.

3. Use the **17** up (^) and down (v) buttons to move the item selection cursor (●) to “Card Save” (or “Save” if you want to save all data) and then press **17** ENTER.

- This displays a screen like the one shown below. (As an example, the remainder of this procedure uses the screen that appears when you perform these steps from the Performance Mode.)

```
PERFORM 1/2#
-----
# Card Save >Ent
# Card Load >Ent
# Clear USER >Ent
```

4. Press **17** ENTER.

```
SAVE PERFM 000-00
-----
UNTITLED.ZPF
-----
--Press Enter
```

5. Enter a number (and, if required, the applicable bank) and file name.

You can perform the following steps to change the initial default file name that is assigned automatically.

- Use the **17** cursor (<, >) buttons to move the cursor to the character you want to change.
- Use the **15** dial or **17** minus (-) and plus (+) buttons to change the character.
  - For details about inputting characters, see “Creating Tones” on page E-12.
  - The characters you can select are shown below.

0	1	2	3	4	5	6	7	8	9
A	B	C	D	E	F	G	H	I	J
K	L	M	N	O	P	Q	R	S	T
U	V	W	X	Y	Z	\$	&	_	'
(	)	-	^	{	}	@	~	`	

- The three characters at the end of a file name are a file name extension, which indicates the type of data stored in the file.

6. After everything is the way you want, press the **17** (ENTER) button.

7. In response to the “Sure?” message that appears, press the **17** YES button to save or the **17** NO button to cancel.

To batch save all Synthesizer data to a memory card

1. Press **7** SETTING.

2. Use the **17** up (^) and down (v) buttons to move the item selection cursor (●) to “CardUtility” and then press **17** ENTER.

- This causes the “CARD UTIL” screen to appear.

3. Use the **17** up (^) and down (v) buttons to move the item selection cursor (●) to “ALL Data” and then press **17** ENTER.

4. Use the **17** up (^) and down (v) buttons to move the item selection cursor (●) to “Save”.

```
ALL DATA#
-----
# Load >Ent
# Save >Ent
```

- The remainder of the steps are the same as those from step 3 under “To save Synthesizer data to a memory card” (page E-88).

#### ■ Memory card Data Storage

The above procedure stores Synthesizer data in a folder named MUSICDAT on the memory card.

- The MUSICDAT folder is created automatically when you format the memory card on the Synthesizer (page E-88).
- Note that files not in the MUSICDAT folder cannot be loaded, deleted, or renamed by this Synthesizer. You also will not be able to load or delete any file stored in any subfolder inside the MUSICDAT folder.

## Loading Data from a Memory Card

### IMPORTANT!

- Make sure that all of the data you want to load is in the MUSICDAT folder on the memory card.

### To load data to Synthesizer memory from a memory card

1. Insert the memory card into the card slot.
2. Referring to the table in step 2 of the procedure under “To save Synthesizer data to a memory card” (page E-88), perform the procedure required for the type of data you want to load from the card.
3. Use the **17** up (^) and down (v) buttons to move the item selection cursor (●) to “Card Load” (or “Load” if you want to load all data) and then press **17** ENTER.
  - This causes a menu screen like the one shown below to appear on the display. The sample screen below shows the screen that appears when you perform this procedure from the Step Sequencer Mode.



4. Use the **15** dial or **17** minus (-) and plus (+) buttons to display the file you want to import.
5. Use the **17** down (v) button to move the cursor downwards, and then use the **15** dial or **17** minus (-) and plus (+) buttons to display the destination of the load operation.
6. Press the **17** ENTER button.
7. In response to the “Sure?” message that appears, press the **17** YES button to load or the **17** NO button to cancel.

### To batch load all Synthesizer memory data from a memory card

1. Press **7** SETTING.
2. Use the **17** up (^) and down (v) buttons to move the item selection cursor (●) to “CardUtility” and then press **17** ENTER.
  - This causes the “CARD UTIL” screen to appear.
3. Use the **17** up (^) and down (v) buttons to move the item selection cursor (●) to “All Data” and then press **17** ENTER.
  - The remainder of the steps are the same as those from step 3 under “To load data to Synthesizer memory from a memory card” (page E-90).

### To delete a file from a memory card

1. Insert the memory card into the card slot.
2. Press **7** SETTING.
3. Use the **17** up (^) and down (v) buttons to move the item selection cursor (●) to “CardUtility” and then press **17** ENTER.
  - This causes the CARD UTIL screen to appear.
4. Use the **17** up (^) and down (v) buttons to move the item selection cursor (●) to “Delete” and then press the **17** ENTER button.
  - This displays a screen for specifying the file to be deleted.



5. Use the **15** dial or **17** minus (-) and plus (+) buttons to display the file you want to delete.
6. Press the **17** ENTER button.
7. In response to the “Sure?” message that appears, press the **17** YES button to delete or the **17** NO button to cancel.
  - Pressing the **17** YES button displays the message “Please Wait” (indicating the operation is in progress). Do not perform any operation while this message is on the display. “Complete!” appears on the display after the operation is complete.

## To rename a file on a memory card

1. Insert the memory card into the card slot.
2. Press **7** SETTING.
3. Use the **17** up (**^**) and down (**v**) buttons to move the item selection cursor (**●**) to “CardUtility” and then press **17** ENTER.
  - This causes the CARD UTIL screen to appear.
4. Use the **17** cursor (**<**, **^**, **v**, **>**) buttons to move the item selection cursor (**●**) to “Rename” and then press the **17** ENTER button.
  - This displays a screen for specifying the file to be renamed.
5. Use the **15** dial or **17** minus (**-**) and plus (**+**) buttons to display the file you want to rename.
6. Use the **17** left (**<**) and right (**>**) buttons to move the cursor to the name character position you want to change, and then use the **15** dial or **17** minus (**-**) and plus (**+**) buttons to select the character you want.
7. After the name is the way you want, press the **17** ENTER button.
8. In response to the “Sure?” message that appears, press the **17** YES button to rename the file or the **17** NO button to cancel.
  - Pressing the **17** YES button displays the message “Please Wait” (indicating the operation is in progress). Do not perform any operation while this message is on the display. “Complete!” appears on the display after the operation is complete.

## Playing a Music File from a Memory Card

You can use the Synthesizer to play music files that you have saved to a card with your computer. For details about the playback method, see “Playing a Demo Tune or a File from a Memory Card” on page E-84.

# Connecting to a Computer

You can connect the Synthesizer to a computer and exchange MIDI data between them. You can send play data from the Synthesizer to commercially available music software running on your computer, or you can send MIDI data from your computer to the Synthesizer for playback.

## Minimum Computer System Requirements

The following shows the minimum computer system requirements for sending and receiving MIDI data. Check to make sure that your computer complies with these requirements before connecting the Synthesizer to it.

### • Operating System

Windows® XP (SP2 or later) \*1

Windows Vista® \*2

Windows® 7\*3

Mac OS® X (10.3.9, 10.4.11, 10.5.X, 10.6.X, 10.7.X)

\*1: Windows XP Home Edition

Windows XP Professional (32-bit)

\*2: Windows Vista (32-bit)

\*3: Windows 7 (32-bit, 64-bit)

### • USB port

## ! IMPORTANT!

- **Never connect to a computer that does not conform to the above requirements. Doing so can cause problems with your computer.**

## Connecting the Synthesizer to Your Computer

## ! IMPORTANT!

- **Make sure you follow the steps of the procedure below exactly. Connecting incorrectly can make data send and receive impossible.**

### 1. Turn off the Synthesizer and then start up your computer.

- Do not start up the music software on your computer yet!

### 2. After starting up your computer, use a commercially available USB cable to connect it to the Synthesizer.

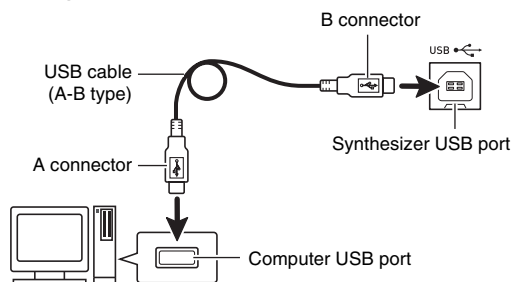

### 3. Turn on the Synthesizer.

- If this is the first time you are connecting the Synthesizer to your computer, the driver software required to send and receive data will be installed on your computer automatically.

### 4. Start up commercially available music software on your computer.

### 5. Configure the music software settings to select one of the following as the MIDI device.

CASIO USB-MIDI : (For Windows 7, Windows Vista, Mac OS X)

USB Audio Device : (For Windows XP)

- For information about how to select the MIDI device, see the user documentation that comes with the music software you are using.

## ! IMPORTANT!

- **Be sure to turn on the Synthesizer first before starting up your computer's music software.**

## NOTE

- Once you are able to connect successfully for the first time, there is no problem with leaving the USB cable connected when you turn off your computer and/or Synthesizer.
- You can alter the Synthesizer's MIDI setup by changing the MIDI data send channel or other settings. For details, see "MIDI Settings" (page E-82).
- For detailed specifications and connections that apply to MIDI data send and receive by this Synthesizer, see the latest support information provided by the website at the following URL.

<http://world.casio.com/>

## Saving and Loading Synthesizer Data to a Computer and Editing Synthesizer Data on a Computer

You can transfer user tones, phrases, and other data you saved with the Synthesizer to a computer for storage. Later, you can return the data back to the Synthesizer when you need it.

You can also edit tone, performance and other Synthesizer data on a computer, where it is easier to work with. A special Data Editor application is required in order to perform operations such as these.

- 1. Go to the CASIO WORLDWIDE site at the following URL.**  
<http://world.casio.com/>
- 2. At the site, select a geographic area or country.**
- 3. After accessing the area site, navigate to the minimum computer system requirements for Data Editor for this product.**
  - You should be able to find a link to Data Editor information on the product introduction page of this product. If you cannot find such a link, use the search form of the area site where you are located to enter the model name of this product and search for it.
  - Note that site contents are subject to change without notice.
- 4. Check if your computer system complies with the minimum requirements for Data Editor.**
- 5. Download Data Editor and its user's guide to your computer.**
- 6. Follow the procedure in the Data Editor user's guide you downloaded in step 5 to install Data Editor.**
- 7. Use the procedures in the Data Editor user's guide to transfer and edit data.**
  - See the Data Editor user's Guide for information about the types of data that can be transferred and the data that can be edited.

## Error Messages

Display Message	Cause	Required Action
<b>Format</b>	<ol style="list-style-type: none"> <li>1. The current memory card format is not compatible with this Synthesizer.</li> <li>2. The memory card capacity is greater than 32GB.</li> <li>3. You are trying to use an SDXC card.</li> <li>4. There is something wrong with the memory card.</li> </ol>	<ol style="list-style-type: none"> <li>1. Format the memory card on the Synthesizer (page E-88).</li> <li>2. Use a memory card with a capacity of 32GB or less.</li> <li>3. SDXC cards not supported. Use an SD or SDHC memory card.</li> <li>4. Use a different memory card.</li> </ol>
<b>Card Full</b>	There is not enough room available on the memory card.	Delete some of the files on the memory card to make room for new data (page E-90), or use a different card.
<b>Card R/W</b>	Memory card data is corrupted.	Use a different memory card.
<b>No Card</b>	<ol style="list-style-type: none"> <li>1. The memory card is not loaded correctly in the Synthesizer's card slot.</li> <li>2. The memory card was removed while some operation was in progress.</li> </ol>	<ol style="list-style-type: none"> <li>1. Correctly load the memory card into the card slot.</li> <li>2. Do not remove the memory card while any operation is in progress.</li> </ol>
<b>No Data</b>	You tried to save a Synthesizer user area (user rhythm, user rhythm song, etc.) that does not contain any data to the memory card.	Select a user area that contains data.
<b>No File</b>	<ol style="list-style-type: none"> <li>1. There is no MUSICDAT folder (page E-89) on the memory card.</li> <li>2. There is no loadable or playable data in the MUSICDAT folder.</li> </ol>	<ol style="list-style-type: none"> <li>1. Create a MUSICDAT folder on the memory card or format the memory card on the Synthesizer (page E-88).</li> <li>2. Move the file you want to load or play into the memory card's MUSICDAT folder.</li> </ol>
<b>Not SMF0/1</b>	You are attempting to play back SMF Format 2 file.	This Synthesizer supports playback of SMF Format 0 or Format 1 only.
<b>Protect</b>	The memory card is write-protected.	Use the memory card's write protect switch to enable writing.
<b>Read Only</b>	A read-only file with the same name you are trying to use is already stored on the memory card.	<ul style="list-style-type: none"> <li>• Use a different name to save the new file.</li> <li>• Remove the read-only attribute from the existing file and overwrite it with the new file.</li> <li>• Use a different memory card.</li> </ul>
<b>Size Over</b>	<ol style="list-style-type: none"> <li>1. The data on the memory card is too big to play.</li> <li>2. The data you are trying to load is too large.</li> <li>3. Chain SMF data size is too large to convert the data and save it to a card.</li> </ol>	<ol style="list-style-type: none"> <li>1. This Synthesizer supports playback of song data files with a maximum size of about 320KB.</li> <li>2. The following is the approximate maximum data sizes (per data item) when loading data into Synthesizer memory. User phrase: 8KB A total of approximately 128KB of user phrase (total of all 100 user presets) can be loaded.</li> <li>3. The Synthesizer can convert up to 320KB of chain SMF data and save it to a card.</li> </ol>
<b>Wrong Data</b>	<ol style="list-style-type: none"> <li>1. The memory card data is corrupted.</li> <li>2. The memory card contains data that is not supported by this Synthesizer.</li> </ol>	Use a different memory card.
<b>Memory Full</b>	There is not enough memory capacity required for phrase sequencer operations.	Shorten the phrase so it takes up less memory space.



Display Message	Cause	Required Action
<b>File Name</b>	When renaming a file on a memory card, attempting to specify a file name that is already used.	Use a different name.
<b>Invalid Tone</b>	You selected a Synthesizer tone for a part other than PART1 (ZONE1).	Select Synthesizer only for PART1 (ZONE1).
<b>Battery Low</b>	Battery power is low.	Replace the batteries or change to AC adaptor power (page E-9).
<b>Write Error!</b>	Writing to internal storage memory failed.	Try again.

## Troubleshooting

Symptom	Action
<b>Included Accessories</b>	
I can't find something that should be included with the product.	Carefully check inside all of the packing materials.
<b>Power Requirements</b>	
Power will not turn on.	<ul style="list-style-type: none"> <li>Check the AC adaptor or make sure that the batteries are facing correctly (page E-9).</li> <li>Replace the batteries with new ones or switch over to AC adaptor power (page E-9).</li> </ul>
The display lights up momentarily but power does not turn on when I press <b>6</b> <b>POWER</b> .	Press <b>6</b> <b>POWER</b> firmly and completely to turn on power.
The Synthesizer outputs a loud sound and then suddenly powers down.	Replace the batteries with new ones or switch over to AC adaptor power (page E-9).
The Synthesizer suddenly powers down after a few minutes.	This happens when Auto Power Off (page E-10) is triggered.
<b>Display</b>	
The display keeps going out or is flashing.	Replace the batteries with new ones or switch over to AC adaptor power (page E-9).
Screen contents are visible only from straight ahead.	This is due to production limitations. It does not indicate malfunction.
<b>Sound</b>	
Nothing happens when I press any keyboard key.	<ul style="list-style-type: none"> <li>Adjust the main volume setting (page E-12).</li> <li>This Synthesizer does not have built-in speakers. It will no produce unless you connect some device for sound output (page E-8).</li> </ul>
No sound is produced when a start the Step Sequencer.	When the arpeggio function is being triggered by start of the Step Sequencer, the sequence will not start until you play something on the keyboard.
Notes keep sounding, without stopping.	Replace the batteries with new ones or switch over to AC adaptor power (page E-9).
Some notes are cut off while they are playing.	Notes are cut off whenever the number of notes being sounded exceeds the maximum polyphony value of 64 (1 to 32 for some tones). This does not indicate malfunction.
The volume or tone setting I configured has changed.	<ul style="list-style-type: none"> <li>Adjust the main volume setting (page E-12).</li> <li>Replace the batteries with new ones or switch over to AC adaptor power (page E-9).</li> </ul>
Output volume does not change even though I change my keyboard pressure.	Change the Touch setting (page E-74).

Symptom	Action
In certain keyboard ranges, the volume and tone quality sound are slightly different from those in other keyboard ranges.	This is due to system limitations. It does not indicate malfunction.
With some tones, octaves do not change at the far ends of the keyboard.	This is due to system limitations. It does not indicate malfunction.
The pitch of the notes does not match other accompanying instruments or sounds strange when played along with other instruments.	Check the transpose and octave shift settings (page E-36).
There is digital noise mixed with the sound when I play high notes with a Solo Synthesizer tone.	This is due to system limitations. It does not indicate malfunction.
The reverb of notes seems to change suddenly.	Check and adjust the reverb setting (page E-36).
<b>Computer Connection</b>	
I can't exchange data between the Synthesizer and a computer.	<ul style="list-style-type: none"> <li>• Check to make sure that the USB cable is connected to the Synthesizer and computer, and that the device is selected correctly with your computer's music software settings (page E-92).</li> <li>• Turn off the Synthesizer and then exit the music software on your computer. Next, turn the Synthesizer back on and then restart the music software on your computer.</li> </ul>

## Specifications

<b>Model</b>	XW-G1
<b>Keyboard</b>	61 standard-size keys
Touch Response	2 types, Off
<b>Maximum Polyphony</b>	64 notes (1 to 32 for some tones)
<b>Tones</b>	420 preset, 220 user
Solo Synthesizer Tones	100 preset, 100 user
PCM Melody Tones	300 preset, 100 user
PCM Drum Tones	20 preset, 10 user
User Wave Tones	10 user
<b>Effects</b>	
Reverb	System reverb
Chorus	System chorus
DSP	100 preset, 100 user
Master Equalizer	53 types (46 normal, 7 Solo Synthesizer) 4 bands
<b>Demo Songs</b>	3 songs
<b>Performance Functions</b>	100 preset, 100 user
<b>Phrase Functions</b>	
Preset Phrases	100
User Phrases	100
Playback Mode	One time, loop
Memory Capacity	128KB
Other	Overdubbing
<b>Step Sequencer Functions</b>	
Preset Sequences	100
User Sequences	100
Number of Tracks	Mono: 8, Poly: 1, Control: 4
Patterns	8 types per sequence
Chains	100
Maximum Steps	16
Other	Phrase function control
<b>Sample Looper Function</b>	
User samples	10
Sampling frequencies	42 kHz, 21 kHz
Sampling channels	Stereo, monaural
Quantization	16bit
<b>Mixer</b>	16 internal parts + Externally input parts
<b>Other Functions</b>	
Transpose	±1 octaves (-12 to 0 to +12 semitones)
Octave Shift	±3 octaves
Tuning	A4 = 415.5 - 440.0 - 465.9 Hz
Arpeggios	Preset: 100 User: 100
<b>MIDI</b>	16 multi-timbre received, GM Level 1 standard
<b>Wheels</b>	Bender, modulation
<b>Memory Cards</b>	
Supported Memory Cards	SD or SDHC memory cards, 32GB or less
Functions	SMF playback, file storage, file recall, file delete, card format

<b>Inputs/Outputs</b>	
USB port	TYPE B
MIDI IN/OUT terminal	IN, OUT
Sustain/Assignable jack	Standard jack (sustain, sostenuto, soft, start/stop)
Phones jack	Stereo standard jack
Line Out R, L/MONO jacks	Standard jack × 2 Output Impedance: 2.3kΩ, Output Voltage: 1.7V (RMS) MAX
Audio In jack	Stereo mini jack Input Impedance: 9kΩ, Input Sensitivity: 200mV
Inst In jack	Standard jack Input Impedance: 9kΩ, Input Sensitivity: 200mV
Mic In jack	Standard jack (connect a dynamic microphone only) Input Impedance: 3kΩ, Input Sensitivity: 10mV Inst In, Mic In A/D conversion: 42 kHz, 10bit
<b>Power Jack</b>	9.5V DC
<b>Power Supply</b>	2-way
Batteries	6 D-size zinc-carbon batteries or alkaline batteries
Battery Life	Approximately 35 hours (alkaline batteries, using the optional CASIO CP-16 headphones)
AC Adaptor	AD-E95100L
Auto Power Off	Approximately 6 minutes after last key operation during battery use, approximately 4 hours after last key operation during AC adaptor use. Auto Power Off can be disabled.
<b>Power Consumption</b>	9.5V --- 4W
<b>Dimensions</b>	94.8 × 38.4 × 12.4 cm (37 3/8 × 15 1/8 × 4 7/8 inch)
<b>Weight</b>	Approximately 5.4kg (11.9 lbs) (without batteries)

• Design and specifications are subject to change without notice.

## Operating Precautions

Be sure to read and observe the following operating precautions.

### ■ Location

Avoid the following locations for this product.

- Areas exposed to direct sunlight and high humidity
- Areas subjected to temperature extremes
- Near a radio, TV, video deck, or tuner  
The above devices will not cause malfunction of the product, but the product can cause interference in the audio or video of a nearby device.

### ■ User Maintenance

- Never use benzine, alcohol, thinner, or other chemical agents to clean the product.
- To clean the product or its keyboard, wipe with a soft cloth moistened in a weak solution of water and a mild neutral detergent. Wring all excess moisture from the cloth before wiping.

### ■ Included and Optional Accessories

Use only accessories that are specified for use with this product. Use of unauthorized accessories creates the risk of fire, electric shock, and personal injury.

### ■ AC Adaptor Handling Precautions

- Use a power outlet that is easily accessible so you can unplug the AC adaptor when a malfunction occurs or whenever else you need to do so.
- The AC adaptor is intended for indoor use only. Do not use it where it might be exposed to splashing or moisture. Do not place any container, such as a flower vase, that contains liquid on the AC adaptor.
- Store the AC adaptor in a dry place.
- Use the AC adaptor in an open, well-ventilated area.
- Never cover the AC adaptor with newspaper, a table cloth, a curtain, or any other similar item.
- Unplug the AC adaptor from the power outlet if you do not plan to use the product for a long time.
- Never try to repair the AC adaptor or modify it in any way.
- AC adaptor operating environment  
Temperature: 0 to 40°C  
Humidity: 10% to 90% RH
- Output polarity: 

### ■ Weld Lines

Lines may be visible on the exterior of the product. These are “weld lines” that result from the plastic molding process. They are not cracks or scratches.

### ■ Musical Instrument Etiquette

Always be aware of others around you whenever using this product. Be especially careful when playing late at night to keep the volume at levels that do not disturb others. Other steps you can take when playing late at night are closing windows and using headphones.

## DSP Effect List

### DSP Type List

#### ■ Normal DSP Types

- Type numbers 01 through 14 are single type DSPs, while numbers 15 through 46 are dual type DSPs. A single type DSP is one with a single structure, while a dual type is a combination of two single type DSPs.
- The name of a dual DSP is formed by its two constituent single DSP names, in the order that they are applied. For example, type 15 named “Wah-Compressor” connects in line to “Wah” and “Compressor”, in that sequence.

Type Number	DSP Type Name	Screen Name
01	Wah	Wah
02	Compressor	Comp
03	Distortion	Dist
04	Enhancer	Enhance
05	AutoPan	AutoPan
06	Tremolo	Tremolo
07	Phaser	Phaser
08	Flanger	Flanger
09	Chorus	Chorus
10	Delay	Delay
11	Reflection	Reflect
12	Rotary	Rotary
13	RingModulator	RingMod
14	Lo-Fi	Lo-Fi
15	Wah-Compressor	WahCmp
16	Wah-Distortion	WahDst
17	Wah-Chorus	WahCho
18	Wah-Flanger	WahFln
19	Wah-Reflection	WahRef
20	Wah-Tremolo	WahTrm
21	Wah-AutoPan	WahPan
22	Compressor-Wah	CmpWah
23	Compressor-Distortion	CmpDst

Type Number	DSP Type Name	Screen Name
24	Compressor-Chorus	CmpCho
25	Compressor-Flanger	CmpFln
26	Compressor-Reflection	CmpRef
27	Compressor-Tremolo	CmpTrm
28	Compressor-AutoPan	CmpPan
29	Distortion-Wah	DstWah
30	Distortion-Compressor	DstCmp
31	Distortion-Chorus	DstCho
32	Distortion-Flanger	DstFln
33	Distortion-Reflection	DstRef
34	Distortion-Tremolo	DstTrm
35	Distortion-AutoPan	DstPan
36	Chorus-Reflection	ChoRef
37	Chorus-AutoPan	ChoPan
38	Flanger-Reflection	FlnRef
39	Flanger-AutoPan	FlnPan
40	Reflection-Distortion	RefDst
41	Reflection-Chorus	RefCho
42	Reflection-AutoPan	RefPan
43	Tremolo-Distortion	TrmDst
44	Tremolo-Chorus	TrmCho
45	Tremolo-Flanger	TrmFln
46	Tremolo-Reflection	TrmRef

- For details about parameters that can be configured with each DSP type, refer to the sections shown in the table below.

For information about this DSP type:	Go here:
Single type (Type numbers 01 through 14)	Normal DSP Single Type DSP Parameters (page E-100)
Dual type (Type numbers 15 through 46)	Normal DSP Dual Type DSP Parameters (page E-102)

#### ■ Solo Synthesizer DSP Types

Type Number	DSP Type Name	Screen Name
	Bypass	Bypass
01	Auto Pan	AutoPan
02	Distortion	Dist
03	Flanger	Flanger

Type Number	DSP Type Name	Screen Name
04	Chorus	Chorus
05	Delay	Delay
06	Ring Modulator	RingMod

- For information about the parameters whose settings can be configured for each DSP type, see “Solo Synthesizer DSP Parameters” (page E-102).

## DSP Parameter List

### ■ Normal DSP Single Type DSP Parameters

#### 01: Wah

This is a “wah” effect that can automatically affect the frequency using an LFO.

##### Parameters and Value Ranges:

- 1 :Resonance (0 to 127)  
Adjusts the strength of resonance.
- 2 :Manual (0 to 127)  
Adjusts the wah filter reference frequency.
- 3 :LFO Rate (0 to 127)  
Adjusts the LFO rate.
- 4 :LFO Depth (0 to 127)  
Adjusts the LFO depth.
- 5 :LFO Waveform (off, sin, tri, random)  
Selects the LFO waveform.

#### 02: Compressor

Compresses the input signal, which can have the effect of suppressing level variation and make it possible to sustain dampened sounds longer.

##### Parameters and Value Ranges:

- 1 :Attack (0 to 127)  
Adjusts the attack amount of the input signal. A smaller value causes prompt compressor operation, which suppresses the attack of the input signal. A larger values delays compressor operation, which causes the attack of the input signal to be output as-is.
- 2 :Release (0 to 127)  
Adjusts the time from the point the input signal drops below a certain level until the compression operation is stopped. When an attack feeling is desired (no compression at the onset of sound), set this parameter to as low a value as possible. To have compression applied at all times, set a high value.
- 3 :Level (0 to 127)  
Adjusts the output level.
- 4 :Threshold (0 to 127)  
Adjusts the volume level at which the compression operation starts.

#### 03: Distortion

Digital distortion that applies an overtone to the input signal and distorts it.

##### Parameters and Value Ranges:

- 1 :Gain (0 to 127)  
Adjusts the input signal gain.
- 2 :Level (0 to 127)  
Adjusts the output level.

#### 04: Enhancer

Phase shifts low-range sounds and high-range sounds of the input signal to enhance the signal's profile.

##### Parameters and Value Ranges:

- 1 :Low Frequency (0 to 127)  
Adjusts the low range enhancer frequency.
- 2 :Low Phase (0 to 127)  
Adjusts the phase shift amount of the low-range enhancer.
- 3 :High Frequency (0 to 127)  
Adjusts the high range enhancer frequency.
- 4 :High Phase (0 to 127)  
Adjusts the phase shift amount of the high-range enhancer.

#### 05: Auto Pan

Performs continual left-right panning of the input signal using an LFO.

##### Parameters and Value Ranges:

- 1 :LFO Rate (0 to 127)  
Adjusts the panning rate.
- 2 :LFO Depth (0 to 127)  
Adjusts the panning depth.
- 3 :LFO Waveform (sin, tri)  
Selects the LFO waveform.
- 4 :Manual (Range: -64 to 0 to 63)  
Adjusts the pan (stereo position).  
-64 is full left, 0 is center, and 63 is full right.

#### 06: Tremolo

Adjusts the volume of the input signal using an LFO.

##### Parameters and Value Ranges:

- 1 :LFO Rate (0 to 127)  
Adjusts the tremolo rate.
- 2 :LFO Depth (0 to 127)  
Adjusts the tremolo depth.
- 3 :LFO Waveform (sin, tri)  
Selects the LFO waveform.

#### 07: Phaser

Produces a distinctive pulsating, broad sound by using an LFO to change the phase of the input signal and then mixes it with the original input signal.

##### Parameters and Value Ranges:

- 1 :Resonance (0 to 127)  
Adjusts the strength of the resonance.
- 2 :LFO Rate (0 to 127)  
Adjusts the LFO rate.
- 3 :LFO Depth (0 to 127)  
Adjusts the LFO depth.
- 4 :LFO Waveform (sin, tri, random)  
Selects the LFO waveform.

**08: Flanger**

Applies wildly pulsating and metallic reverberation to sounds. LFO waveform is selectable.

**Parameters and Value Ranges:**

- 1 :LFO Rate (0 to 127)  
Adjusts the LFO rate.
- 2 :LFO Depth (0 to 127)  
Adjusts the LFO depth.
- 3 :LFO Waveform (sin, tri, random)  
Selects the LFO waveform.
- 4 :Feedback (0 to 127)  
Adjusts the strength of feedback.

**09: Chorus**

Gives sounds depth and breadth. Chorus type is selectable.

**Parameters and Value Ranges:**

- 1 :LFO Rate (0 to 127)  
Adjusts the LFO rate.
- 2 :LFO Depth (0 to 127)  
Adjusts the LFO depth.
- 3 :LFO Waveform (sin, tri)  
Selects the LFO waveform.
- 4 :Feedback (0 to 127)  
Adjusts the strength of feedback
- 5 :Type (mono, stereo, tri)  
Selects the chorus type.

**10: Delay**

Delays the input signal and feeds it back to create a repeating effect and give sounds more breadth.

**Parameters and Value Ranges:**

- 1 :Delay Time (0 to 127)  
Adjusts the delay time.
- 2 :Feedback (0 to 127)  
Adjusts the repeat of the delay.
- 3 :Ratio Lch (0 to 127)  
Adjusts the delay time of the left channel. This value is a ratio of the value specified for Delay Time.
- 4 :Ratio Rch (0 to 127)  
Adjusts the delay time of the right channel. This value is a ratio of the value specified for Delay Time.
- 5 :Wet Level (0, 1, 2, 3, 4, 5)  
Adjusts the level of the delay sound.
- 6 :Type (1, 2)  
Selects the delay type.
  - 1 :Delay repeat determined by Delay Time.
  - 2 :Delay repeat determined by Delay Time and Ratio L/R.
- 7 :Tempo Sync (Range: Off, 1/4, 1/3, 3/8, 1/2, 2/3, 3/4, 1, 4/3, 3/2, 2)  
Adjusts the relationship between tempo and delay time of the Sequencer.  
When Off is selected, the current setting of the Delay Time parameter is used for the delay time. When any other setting is selected, the delay time is synced with the Sequencer beat.  
Selecting 1, for example, the delay time is approximately equal to the length of one beat.  
(Delay time is not precisely synced with the beat.)

**Important!**

When adjusting the delay time and type, certain settings can result in a switching sound in the delay.

**11: Reflection**

An effector that extracts early reflections from reverb. Applies acoustic presence to sounds.

**Parameters and Value Ranges:**

- 1 :Type (1, 2, 3, 4, 5, 6, 7, 8)  
Selects from among the eight available reflection patterns.
- 2 :Feedback (0 to 127)  
Adjusts the repeat of the reflected sound.

**12: Rotary**

This is a rotary speaker simulator.

**Parameters and Value Ranges:**

- 1 :Overdrive Gain (0, 1, 2, 3)  
Adjusts overdrive gain.
- 2 :Overdrive Level (0 to 127)  
Adjusts the overdrive output level.
- 3 :Speed (Slow, Fast)  
Switches the speed mode between fast and slow.
- 4 :Brake (Rotate, Stop)  
Stops speaker rotation.
- 5 :Fall Acceleration (0 to 127)  
Adjusts acceleration when the speed mode is switched from fast to slow.
- 6 :Rise Acceleration (0 to 127)  
Adjusts acceleration when the speed mode is switched from slow to fast.
- 7 :Slow Rate (0 to 127)  
Adjusts the speaker rotation speed in the slow speed mode.
- 8 :Fast Rate (0 to 127)  
Adjusts the speaker rotation speed in the fast speed mode.

**13: Ring Modulator**

Multiplies the input signal with an internal oscillator signal to create a metallic sound.

**Parameters and Value Ranges:**

- 1 :OSC Frequency (0 to 127)  
Sets the reference frequency of the internal oscillator.
- 2 :LFO Rate (0 to 127)  
Adjusts the LFO rate.
- 3 :LFO Depth (0 to 127)  
Adjusts the LFO depth.
- 4 :Type (1, 2, 3)
  - 1 :Outputs the ring modulated signal only.
  - 2 :Outputs the ring modulated signal and the input signal.
  - 3 :Outputs a signal with a chorus effect applied to 2 (ring modulated signal and input signal).

### 14: Lo-Fi

Applies various types of noise to the input signal to reproduce a retro Lo-Fi sound.

Includes wow and flutter for rotational fluctuation like that in tapes and records, a Noise 1 generator that generates continual FM radio type, and a Noise 2 generator that generates record play types scratch noise.

**Parameters and Value Ranges:**

- 1 :Wow and Flutter Rate (0 to 127)  
Adjusts the wow and flutter rate.
- 2 :Wow and Flutter Depth (0 to 127)  
Adjusts the wow and flutter depth.
- 3 :Noise1 Level (0, 1, 2, 3, 4, 5)  
Adjusts the level of Noise Generator 1.
- 4 :Noise2 Level (0, 1, 2, 3, 4, 5)  
Adjusts the level of Noise Generator 2.
- 5 :Noise2 Density (0, 1, 2, 3, 4, 5)  
Adjusts the frequency of Noise Generator 2.
- 6 :Bit (0, 1, 2, 3)  
Distorts the sound. A larger number produces greater distortion.

**Important!**

Raising the noise level while a note is not sounding will cause noise to sound, even if there is no input signal.

**Normal DSP Dual Type DSP Parameters**

Dual type DSPs are configured by combining two different single type DSPs. Use the procedure below to determine what parameters that can be configured for each dual type DSP, and the operation, and setting ranges of dual type DSPs.

Example: Type number 29: Distortion-Wah

- 1. The DSP type name has two parts: a left side part and a right side part.  
Distortion-Wah → “Distortion” and “Wah”
- 2. Find out what parameters you can configure by looking up the left side part of a dual type DSP in the “Type Name” column of the table below.

Type Name	Configurable Parameters
Wah	LFO Waveform LFO Rate LFO Depth
Distortion	Gain Level
Chorus	LFO Waveform LFO Rate LFO Depth
Flanger	LFO Waveform LFO Rate LFO Depth
Reflection	Feedback
Compressor	Threshold Level
Auto Pan	LFO Waveform LFO Rate LFO Depth Manual
Tremolo	LFO Waveform LFO Rate LFO Depth

- 3. Find the same type names in the table under “Normal DSP Single Type DSP Parameters” on pages E-100 through E-102, and note the operation and setting ranges of the items that are the same as those shown in the “Configurable Parameters” column of the above table.

- In our “Distortion-Wah” example, the left side part of the name is “Distortion” so we can see in the above table that “Gain” and “Level” parameters can be configured. You can find out about the operations and setting ranges of “Gain” and “Level” by referring to “03: Distortion” on page E-100.

- 4. Next, repeat steps 2 and 3 above for the right side part of the dual type DSP parameter name.

- The parameter numbers that appear on the parameter setting screen start from 1, and the number is incremented for each successive parameter. The parameter numbers of our “Distortion-Wah” example would be as shown below.

- 1: Gain
- 2: Level
- 3: LFO Waveform
- 4: LFO Rate
- 5: LFO Depth

**Solo Synthesizer DSP Parameters**

- (Param A) and (Param B) are parameters assigned to the **5 8/16 and MASTER sliders** when Solo Synthesizer tones are selected.

**(No number): Bypass**

Selecting this option disables application of DSP.

**No parameters**

**01: Auto Pan**

**Parameters and Ranges**

- 1 :LFO Waveform (Range: sin, tri)
- 2 :LFO Rate (Range: 0 to 127) (Param A)
- 3 :LFO Depth (Range: 0 to 127) (Param B)
- 4 :Manual (Range: -64 to 0 to 63)

**02: Distortion**

**Parameters and Ranges:**

- 1 :Gain (Range: 0 to 127) (Param A)
- 2 :Level (Range: 0 to 127) (Param B)

**03: Flanger**

**Parameters and Ranges**

- 1 :LFO Waveform (Range: sin, tri, random)
- 2 :LFO Rate (Range: 0 to 127) (Param A)
- 3 :LFO Depth (Range: 0 to 127) (Param B)

**04: Chorus**

**Parameters and Ranges**

- 1 :LFO Waveform (Range: sin, tri)
- 2 :LFO Rate (Range: 0 to 127) (Param A)
- 3 :LFO Depth (Range: 0 to 127) (Param B)



**05: Delay****Parameters and Ranges**

- 1 :Delay Time (Range: 0 to 127) (Param A)
- 2 :Feedback (Range: 0 to 127)
- 3 :Damp (Range: 0 to 3)  
Adjusts damping of the high-range. 3 results in maximum damping.
- 4 :Wet Level (Range: 0, 1, 2, 3, 4, 5) (Param B)
- 5 :Tempo Sync (Range: Off, 1/4, 1/3, 3/8, 1/2, 2/3, 3/4, 1, 4/3, 3/2, 2)

**06: Ring Modulator****Parameters and Ranges**

- 1 :Frequency (Range: 0 to 127) (Param A)  
Adjusts the modulation frequency of the ring modulator.
- 2 :Dry Level (Range: 0 to 127)  
Adjusts the level of the original sound.
- 3 :Wet Level (Range: 0 to 127) (Param B)  
Adjusts the sound level of the ring modulator.

- For information about parameters not included in the above, see the explanations of the parameters with the same names under “Normal DSP Single Type DSP Parameters” (page E-100).

**Supported Input Characters**

!	"	#	\$	%	&	'	(	)	
*	+	,	-	.	/	0	1	2	3
4	5	6	7	8	9	:	;	<	=
>	?	@	A	B	C	D	E	F	G
H	I	J	K	L	M	N	O	P	Q
R	S	T	U	V	W	X	Y	Z	[
\	]	^	_	`	a	b	c	d	e
f	g	h	i	j	k	l	m	n	o
p	q	r	s	t	u	v	w	x	y
z	{		}	~					

# MIDI Implementation Chart

Function	Transmitted	Recognized	Remarks
<b>Basic Channel</b> Default Changed	1 - 16 1 - 16	1 - 16 1 - 16	
<b>Mode</b> Default Messages Altered	Mode 3 X * * * * * * * * * *	Mode 3 X * * * * * * * * * *	
<b>Note Number</b> True voice	0 - 127 * * * * * * * * * *	0 - 127 0 - 127 *1	
<b>Velocity</b> Note ON Note OFF	0 9nH v = 1 - 127 X 9nH v = 0	0 9nH v = 1 - 127 X 9nH v = 0, 8nH v = **	** : no relation
<b>After Touch</b> Key's Ch's	X X	X O	
<b>Pitch Bender</b>	O	O	
<b>Control Change</b> 0 1 5 6, 38 7 10 11 16 - 19 64 65	O O O *2 O *2 O O O X O *2 O *3 O *2	O O O *2 O *2 O O O O O *2 O *3 O *2	Bank select Modulation Portamento Time Data entry LSB, MSB Volume Pan Expression Hold 1 Portamento On/Off

66 67 70 - 90 91 93 98, 99 100, 101	<input type="radio"/> *3 <input type="radio"/> *3 <input type="radio"/> *2 <input type="radio"/> *2 <input type="radio"/> *2 <input type="radio"/> *2 <input type="radio"/> *2	<input type="radio"/> *3 <input type="radio"/> *3 <input type="radio"/> *2 <input type="radio"/> *2 <input type="radio"/> *2 <input type="radio"/> *2 <input type="radio"/> *2	<input type="radio"/> *3 <input type="radio"/> *3 <input type="radio"/> *2 <input type="radio"/> *2 <input type="radio"/> *2 <input type="radio"/> *2 <input type="radio"/> *2	Sostenuto Soft pedal  Reverb send Chorus send NRPN LSB, MSB RPN LSB, MSB
<b>Program Change</b> : True #	<input type="radio"/> * * * * * <input type="radio"/> * * * * *	<input type="radio"/> * * * * * <input type="radio"/> * * * * *	<input type="radio"/> * * * * * <input type="radio"/> * * * * *	<input type="radio"/> * * * * * <input type="radio"/> * * * * *
<b>System Exclusive</b>	<input type="radio"/> *2	<input type="radio"/> *2	<input type="radio"/> *2	<input type="radio"/> *2
<b>System Common</b> : Song Pos : Song Sel : Tune	<input checked="" type="checkbox"/> * <input checked="" type="checkbox"/> * <input checked="" type="checkbox"/> *	<input checked="" type="checkbox"/> * <input checked="" type="checkbox"/> * <input checked="" type="checkbox"/> *	<input checked="" type="checkbox"/> * <input checked="" type="checkbox"/> * <input checked="" type="checkbox"/> *	<input checked="" type="checkbox"/> * <input checked="" type="checkbox"/> * <input checked="" type="checkbox"/> *
<b>System Real Time</b> : Clock : Commands	<input type="radio"/> * <input type="radio"/> *	<input type="radio"/> * <input type="radio"/> *	<input type="radio"/> * <input type="radio"/> *	<input type="radio"/> * <input type="radio"/> *
<b>Aux Messages</b> : All sound off : Reset all controller : Local ON/OFF : All notes OFF : Active Sense : Reset	<input checked="" type="checkbox"/> * <input type="radio"/> * <input checked="" type="checkbox"/> * <input type="radio"/> * <input checked="" type="checkbox"/> * <input checked="" type="checkbox"/> *	<input checked="" type="checkbox"/> * <input type="radio"/> * <input checked="" type="checkbox"/> * <input type="radio"/> * <input checked="" type="checkbox"/> * <input checked="" type="checkbox"/> *	<input checked="" type="checkbox"/> * <input type="radio"/> * <input checked="" type="checkbox"/> * <input type="radio"/> * <input checked="" type="checkbox"/> * <input checked="" type="checkbox"/> *	<input type="radio"/> * <input type="radio"/> * <input type="radio"/> * <input type="radio"/> * <input type="radio"/> * <input checked="" type="checkbox"/> *
<b>Remarks</b>	*1: Depends on tone. *2: See MIDI Implementation at <a href="http://world.casio.com/">http://world.casio.com/</a> . *3: In accordance with pedal effect setting.			

Mode 1 : OMNI ON, POLY  
 Mode 3 : OMNI OFF, POLY  
 Mode 2 : OMNI ON, MONO  
 Mode 4 : OMNI OFF, MONO  
 O : Yes  
 X : No



This recycle mark indicates that the packaging conforms to the environmental protection legislation in Germany.

**CASIO®**