

LED DISPLAY SYSTEM

TABLE OF CONTENTS

| | |
|--|---|
| Key Features | 1 |
| Keyboard layout..... | 2 |
| IR remote operation instruction diagram..... | 3 |

IR SECTION

| | |
|--|-----|
| Getting started..... | 4 |
| Programming a simple message | |
| Programming alternate characters..... | 5 |
| Display letters, numbers, symbols, European, Pre-leading messages, Graphics page. | |
| Attention getting features..... | 6-7 |
| Selecting text colors, font sizes. | |
| Advanced features..... | 7-9 |
| Special effects schedule display Display Date&Time, Running combined pages, Resetting system, Setting ID address, Setting brightness, Setting system clock. | |

SOFTWARE SECTION

| | |
|---|-------|
| System Requirements and Running the setup..... | 10-12 |
| The Software Screen..... | 12 |
| Set-Up..... | 12 |
| Connecting the cable | |
| The menu bar..... | 13-15 |
| Menu Bar functions and features, European char table. | |
| Sending a message..... | 15 |
| Sending a message to sign after Set-Up | |
| The bmp graphic editor..... | 16-19 |
| Editting and displaying graphics, Color window, Edit button, Edit function, Display zoom in or out, Color selection | |
| LAN communication..... | 19-22 |
| Setting up the RSC and TMC to send messages via the LAN | |

TABLE OF CONTENTS

| | |
|--|-------|
| Internet e-mail communication..... | 22-23 |
| Setting up the RTC and TMC to send messages via the Internet. | |

ⓘ QUICK REFERENCE SECTION..... 23

| | |
|----------------------------------|-------|
| Color code table..... | 23 |
| Font size table..... | 23 |
| European table..... | 24 |
| Special effects table..... | 24 |
| Display effect, speed, time..... | 25 |
| Help section..... | 26-27 |

PLEASE READ BEFORE STARTING

This manual contains three overall sections:



IR Remote Section

Programming your new sign using the included IR Remote Keyboard



Software Section

Programming your new sign using the included Software



Quick Reference Section

Corresponding Codes for IR Remote Keyboard



Help Section

Most commonly asked questions, troubleshooting, contacting technical support

The step-by-step process of explanation will help you accomplish a few examples before starting on your own.

KEY FEATURES

COLORS AND FONT SIZES

By combining colors and different font sizes, the LED display will allow you to advertise and capture your customers attention like never before.

VISUAL TEXT EFFECTS AND GRAPHICS

With such functions as cycling, scroll-up, scroll down, and overlap, advertising has never been so much fun! powerful graphics editor can create your own to make your messages stand out!

DEPENDABILITY AND DURABILITY

All of our signs are manufactured under strict quality controls for years of problem free operation. The aluminum casing minimizes interference and assures reliability wherever it is installed.

LARGE MEMORY AND MESSAGE STORAGE

The led display system is equipped with 32K of memory with the capability to retain your programmed information for up to 30 days when not used.

* Internal back-up battery.

SCHEDULE DISPLAY FUNCTION

To display different message with different time/date. One touch easy operation press one key to display date and time or pre-loading message.

Led display system Software for use with Windows 98 and higher
Please see the Software Section, for all the features!

KEYBOARD LAYOUT

INFRA-RED REMOTE KEYBOARD LAYOUT

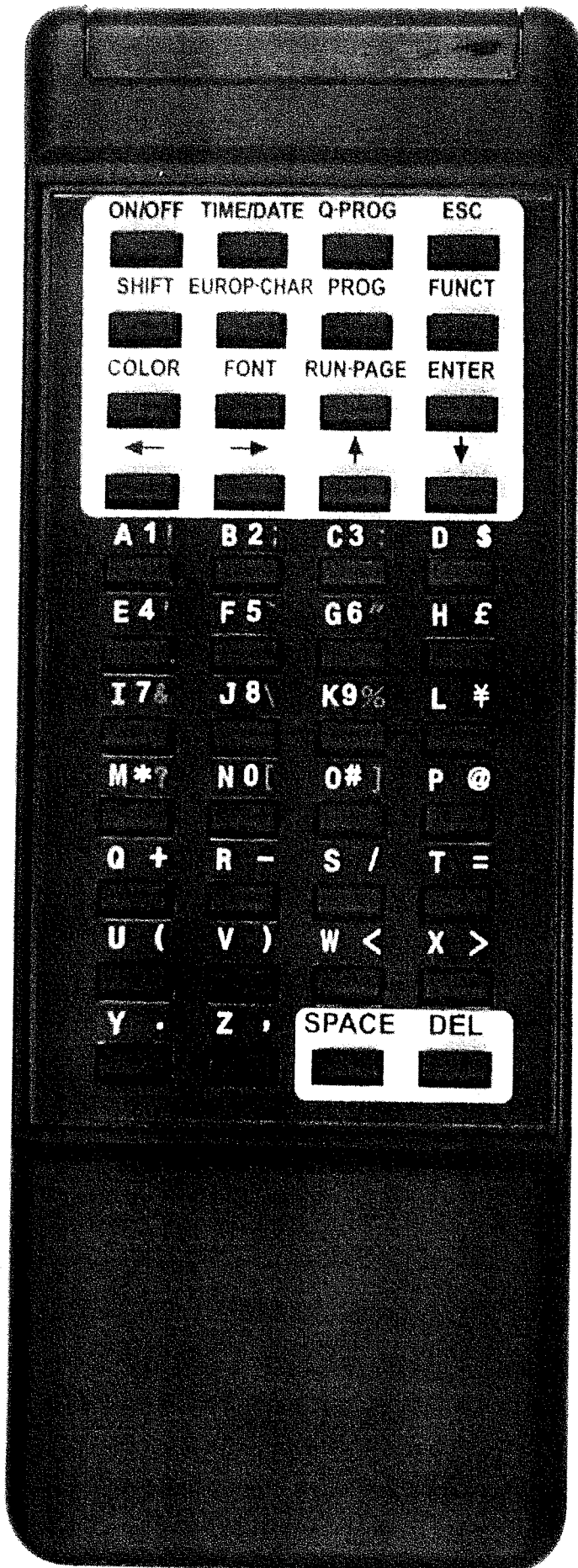

Command Keys

Keys located in the yellow area

Character Keys

Keys outside the yellow area

Upper Case Keys (26) A-Z

Lower Case Keys (26) a-z

Numeric (10) 0-9

Symbols (29) !; ...

European (64) Å

Please refer to page 6-7 for instructions on displaying European characters

NOTE:

IR keyboard must be pointed at the built-in infra-red sensor located on the top left hand corner of the sign.

Optimum operating distance should be around 5' to 30'.

DO NOT subject the remote keyboard to impact, water or excessive humidity.

The remote keyboard operates on two R6 (UM/SUM-3, AA) or AAA 1.5-volt batteries. Batteries not included.

Inserting Batteries

Battery Cover

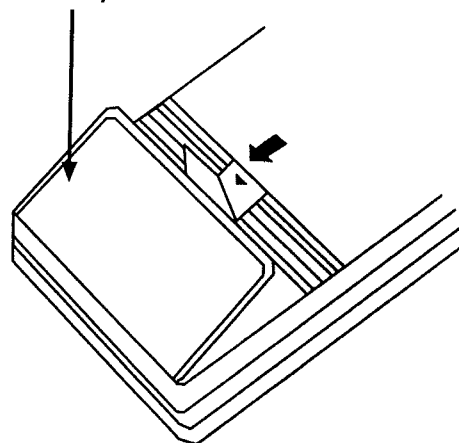



IR REMOTE OPERATION INSTRUCTION DIAGRAM

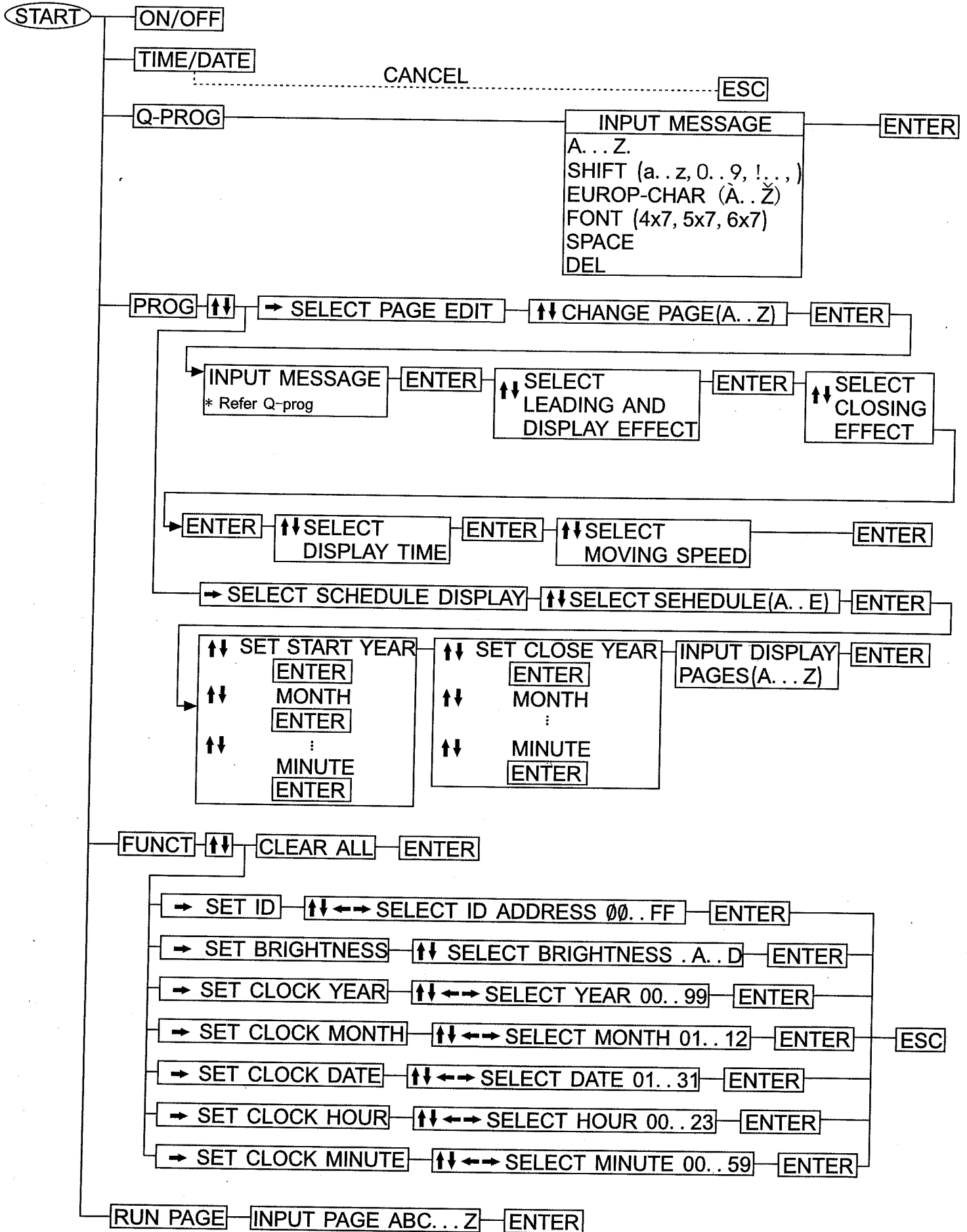

** For 2 line display only.

IR SECTION **GETTING STARTED BY REMOTE CONTROL**

PRESS **ON/OFF**

The sign will display on and off

PRESS **TIME/DATE---**ESC** (OFF)**

To display the time and date message only, press **ESC** to cancel time/date display function.

Programming a simple message with **Q-PROG**

Let's practice how to program a simple message by following the steps below. Make sure your sign is currently running a message.

| <u>Press</u> | <u>Display</u> | <u>Description</u> |
|--|----------------|--|
| 1. Q-PROG | | Stop the sign and wait for message input |
| 2. H E L L O SPACE | HELLO | Key-in "HELLO" using the character keys |
| TIP: If you key-in a wrong character, press DEL to delete the last character entered. | | |
| 3. ENTRE | HELLO HELLO | Runs the message you programmed |

PROGRAMMING ALTERNATE CHARACTERS

Display lower-case Letters, numbers, and symbols using the

SHIFT key.

Please take notice of the INDICATION BLOCK, which appears on the left hand corner of the sign whenever the **SHIFT** key is pressed in the following steps.

1. Press **Q-PROG** to stop the sign. and program a message
2. Press **A** to display the letter "A".
3. Press the **SHIFT** key once. Now press any one of the letter character keys on the IR Remote. character keys active (lower-case mode).
4. Press **SHIFT** again. Now press any one of the white number character keys on the IR Remote. white character keys active (numerical mode).
5. Press the **SHIFT** key again. Now press any one of the green symbols character keys on the IR Remote. green character keys active (symbols mode).
6. Press **SHIFT** again to return you to the upper-case mode. Press any letter key to verify that you are back in the upper-case mode.

NOTE: Upper-Case mode is the default selection when beginning to program. Once you press the **SHIFT** key, you are no longer in the upper-case mode. Follow steps 3 - 6 to toggle between modes.

7. Press **ENTER** to run your message.

Displaying European characters using the **EUROP-CHAR** key.

1. Press **Q-PROG** to stop the sign. and program a message.
2. Press **A** to display the letter "A".
3. Now press the **EUROP-CHAR** key. As you will notice, the letter "A" has now changed its shape to the European letter. Continue to press the **EUROP-CHAR** key until you reach the European style "A" of your choice.

TIP: To revert back to the normal character, continue to press **EUROP-CHAR**. Also, you can press any letter at any time to continue to type normal characters.

4. Following previous steps 2 and 3, try to display the European character for the letter "U".
5. Press **ENTER** to run your message.

PROGRAMMING ALTERNATE CHARACTERS

Displaying European characters in lower-case using the and **SHIFT** **EUROP-CHAR** key.

1. Press **Q-PROG** to stop the sign. Press and program a message.
2. Press the **SHIFT** key once to go into the lower-case mode. Remember, the **SHIFT** key toggles you from 4 different modes. Upper case, lower-case, numerical, and symbols mode.
3. Now press **C** to display the letter "C" in lower-case.
4. Now press the **EUROP-CHAR** key. As you will notice, the letter "c" has now changed its shape to the European.
5. While staying in the lower-case mode, try to display the European character for the letter "o".
6. Press **ENTER** to run your message.

NOTE: There are 64 European characters that you can choose from. Please refer to the Quick Reference Guide for the European Characters Table and corresponding letters.

TIP : Use the letter "G" with **EUROP-CHAR** to display some Greek characters.

ATTENTION GETTING FEATURES

Displaying pre-loading message or graphics page.

Let's say you had pre-loaded a message to page e and you wanted to display

| <u>Press</u> | <u>Display</u> | <u>Description</u> |
|--------------------|----------------|-----------------------------------|
| 1. RUN-PAGE | STOP MODE | Stops the sign and wait page data |
| 2. E | (PG:E) | Display PAGE E |
| 3. ENTER | | Runs your message |

NOTE : There are 26 pages can pre-loading message that you can select to display from A To Z.

Link display pre-loading message

| <u>Press</u> | <u>Display</u> | <u>Description</u> |
|--------------------|----------------|-------------------------|
| 1. RUN-PAGE | STOP MODE | STOP AND WAIT PAGE DATA |
| 2. A B E | (PG:A,B,E) | DISPLAY PAGE A,B,E |
| 3. ENTER | | RUNS YOUR MESSAGE. |

ATTENTION GETTING FEATURES

Using the **COLOR key to select a text color.**

1. Press **Q-PROG** to stop the sign and program a message.
2. Press **S U** to display the letter.
3. Press the **COLOR** key. as you will notice "SU" have now changed to different color.
4. Now press **COLOR** key again to view the different text colors. Once you see the color you wish to use, Your color has now been selected. The color you select will stay active until another color is chosen.
5. Key in the word "SUCCESS".
6. Press **ENTER** to run your message.

NOTE: Please refer to the quick reference section for the color table.

Using the **FONT key to select font sizes.**

1. Press **Q-PROG** to stop the sign and program a message.
2. Press **A B** to display the letter.
3. Press the **FONT** key, as you will notice "AB" have now changed to different font.
4. Now press the **FONT** key again to view the different font sizes. Once you see the font size you which to use. Your font size has now been selected. The font you select will stay active until another font is chosen.

5. Key in the word "ABLE" .
6. Press **ENTER** to run your message.

NOTE : There are many font sizes that you can select from. Please refer to the Quick Reference Section, for the Font Size Table.

ADVANCED FEATURES

Adding special effects to your message using the **PROG key.**

Now the real fun begins! Let's program a message using the effect

1. Press **PROG** to program a message.
2. Press **↓** select page edit function.
3. Press **→** to select PAGE A. (Total 26 page can be selected from A..Z)
4. Press **↑** **↓** to program PAGE A. The sign will read: (PAG: A)
5. Press the **ENTER** to edit PAGE A
6. Key-in the word "COOL".
7. Press the **ENTER** The Sign will wait for effect input.
8. Now press the **↑** **↓** keys to scroll through the various leading and display effect
9. Press **ENTER** when you confirm the effect selection.
10. Press **↑** **↓** keys to scroll through the closing effect.
11. Press **ENTER** when you confirm the effect selection.
12. Press **↑** **↓** keys to select the display time.
13. Press **ENTER** to confirm the display time.
14. press **↑** **↓** keys to select leading and closing effect moving speed from "0.
15. Press **ENTER** when you confirm.

NOTE : There are many effects that you can select from. Please refer to quick Reference Guide for the Effects Table and corresponding letters.

Adding schedule display using the **PROG key**

1. Press **PROG** to stop the display.
2. Press **↓** **↓** to program schedule display.
3. Press **→** to enter the schedule selection.
4. Press **↑** to set up the schedule display time. max 5 schedule can be set up from A to E.
5. Press **ENTER** to confirm schedule timer selection.
6. Press **→** **←** to select starting year field.
7. Press **↑** **↓** to edit the year.
8. Press **ENTER** to confirm year input and go to start, month input.
9. Press **→** **←** to select starting month field.
10. Press **↑** **↓** to edit the month.
11. Press **ENTER** to confirm month input and goto start date input.
12. Press **→** **←** to select starting date field.

13. Press **↑** **↓** to edit the date.
14. Press **ENTER** to confirm date input and goto start hour input.
15. Press **→** **←** to select starting hour field.
16. Press **↑** **↓** to edit the hour.
17. Press **ENTER** to confirm hour input and goto start minute input.
18. Press **→** **←** to select starting minute field.
19. Press **↑** **↓** to edit the minute.
20. Press **ENTER** to confirm minute input and goto closing year input.
21. Repeat step 6 to 20 to complete the closing timer set up and you will see "**".
22. Press characters key A,B,C...Z to input display page for the schedule.
 - * Press **DEL** if input is wrong.
23. Press **ENTER** to confirm the schedule set up.
 - * There are max 5 display schedule from A to E can be set. Please repeat step 1 to 23 to complete the next schedule setting.
 - * If you want to cancel the schedule display, please refer "resetting system using the **FUNCT** key" procedure.

ADVANCED FEATURES

Displaying the time and date using the **TIME/DATE key.**

1. Press the **TIME/DATE** key to ENTER
the date/time display mode, date & time will display alternatively for 3 second.

Cancel display the time and date using the **ESC key.**

1. Press **ESC** and wait 3 sec.
the display will back to normal message display.

Running combined Pages using the **RUN PAGE key.**

This feature allows you to link up to 26 pages together as one long message. Remember to have your messages programmed before setting this feature.

1. Press **RUN PAGE** to stop the sign.
2. Press the **A to Z** key. to select the 'select run' pages, press ENTER to confirm
3. Key in the pages **A** **B** **C** to run the page link A and B and C.
4. Key in **ENTER** to run message.

Resetting system using the **FUNCT key**

* Any time you can press **ESC** to skip the set up process.

1. Press **FUNCT** to enter the set up function
2. Press **↓** key select "clear all Y?"
3. Press **ENTER** key.

Setting id address using the **FUNCT** key

1. Press **FUNCT** to enter set up function
2. Press **↓ ↓** key to select "ADD00"
3. Press **→ ←** to select the address field
4. Press **↑ ↓** to edit the address from 00 to ZZ
5. Press **ENTER** to confirm address set up.
6. Press **ESC** to return to normal display

*Address ID set up only for more than one display sign connect with one data cable. That the data can be separated send to the display from PC with ID address.

Setting brightness using the **FUNCT** key

1. Press **FUNCT** to enter set up function
2. Press **↓ ↓ ↓** to brightness set up function
3. Press **→** to select brightness field.
4. Press **↑ ↓** to edit brightness level from high to low "A..D".
5. Press **ENTER** to confirm brightness set up.
6. Press **ESC** to return to normal display

ADVANCED FEATURES

Setting system clock using the **FUNCT** key.

1. Press **FUNCT** to enter set up function
2. Press **↓ ↓ ↓ ↓** to set up year data
3. Press **→ ←** to select the year field.
4. Press **↑ ↓** to edit the year data.
5. Press **ENTER** to confirm year setting.
6. Press **↓** to set up month data.
7. Press **→ ←** to select the month field.
8. Press **↑ ↓** to edit the month data.
9. Press **ENTER** to confirm month setting.
10. Press **↓** to set up date data.
11. Press **→ ←** to select the date field.
12. Press **↑ ↓** to edit the date data.
13. Press **ENTER** to confirm date setting.
14. Press **↓** to set up hour data.
15. Press **→ ←** to select the hour field.
16. Press **↑ ↓** to edit the hour setting.
17. Press **ENTER** to confirm hour setting.
18. Press **↓** to setup minute data.
19. Press **→ ←** to select the minute field.
20. Press **↑ ↓** to edit the minute data.
21. Press **ENTER** to confirm minute setting.
22. Press **ESC** back to normal message display.

PC system required

Operating System: Win98/Win me/Win NT/ Win 2000/Win XP

CPU: Intel Pentium 166 or above

RAM: 32M or above

Monitor: VGA or higher

Serial Output: RS232 port

Software installation instructions

Insert the LED Display System disk into your CD-ROM drive. That will auto-run and the first screen comes up.

Click INSTALL to go installation. Choose READ ME to show you the required system. EXIT will quit the installation.

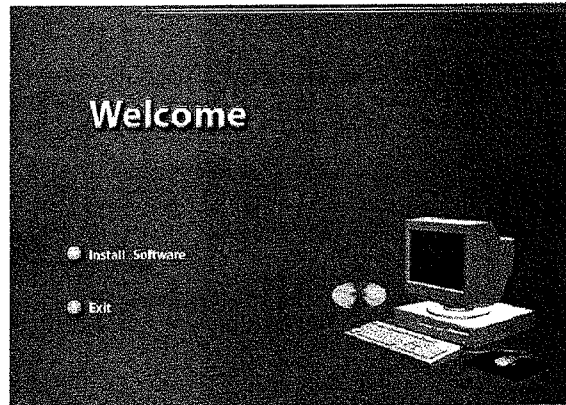

Click INSTALL to go ahead the installation and continue the
Choose Next to continue, Click
BROWSE to select the directory to install the program. The system
preset is C:\Program Files\New sign.

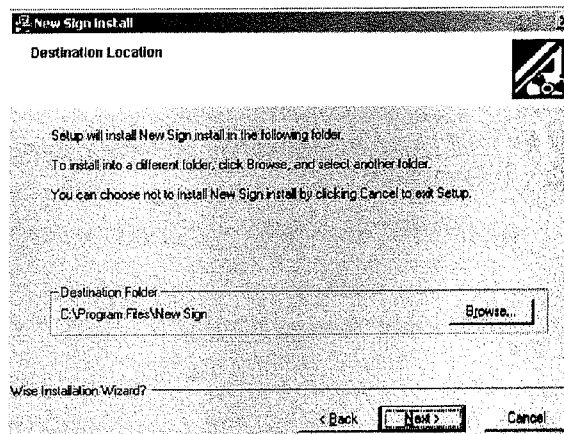
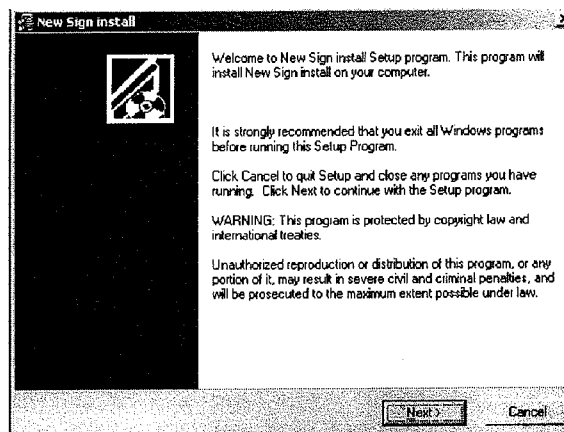

Click NEXT to keep on installation
Choose NEXT to run the file installation to copy
the file to your PC hard disk. Choose CANCEL to quit installation
program or BACK to change the directory setting.

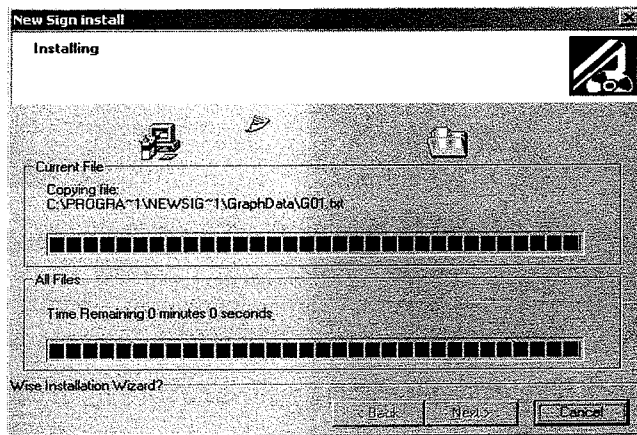
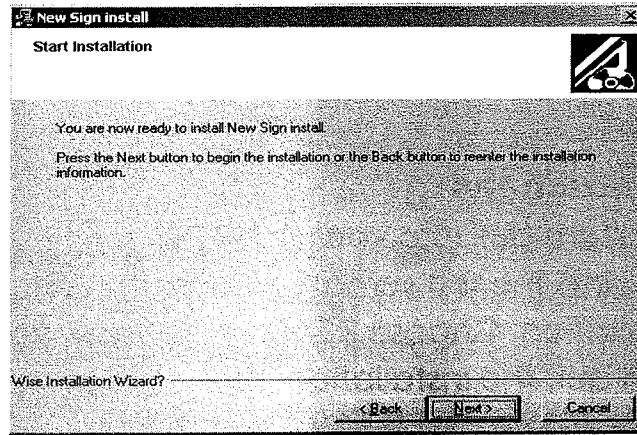

After copying the file is complete, click on Finish.
Finish the installation, and shortcut icon for quick
start will be on the desktop screen. And simultaneously create
DIRECTORY in your PC program group.

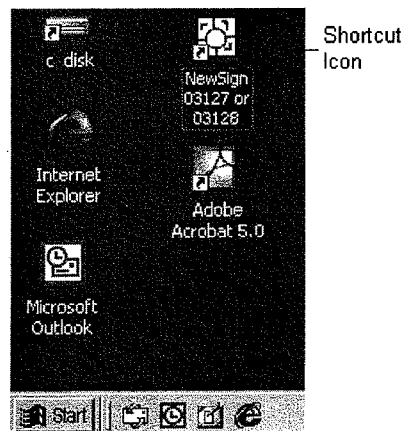

If you want to uninstall the system, just double-click the unwise.
exe at the Program Group\ New Sign.

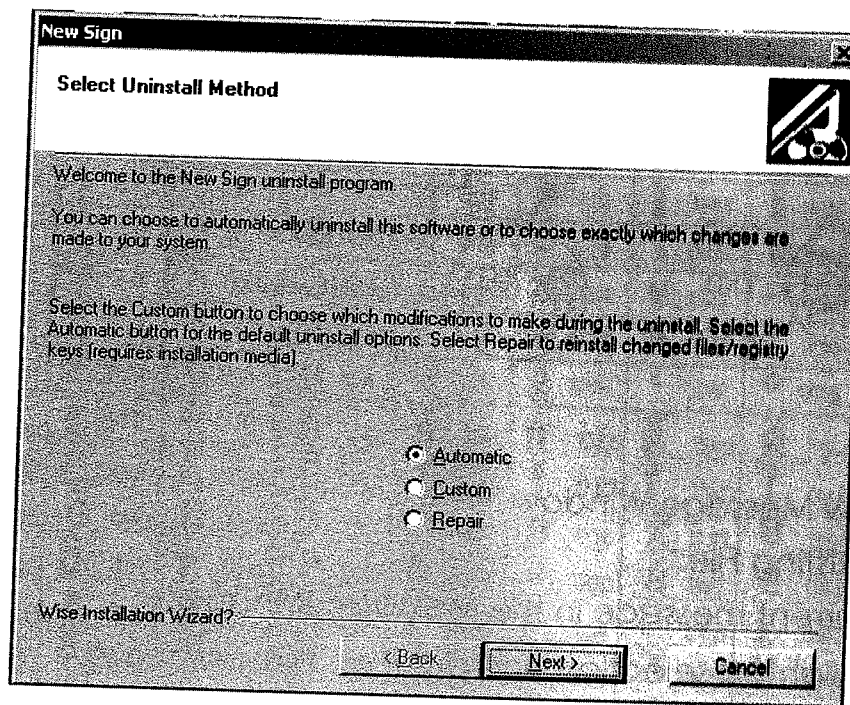

Select Automatic and click NEXT. The program will automatically uninstall.

SOFTWARE SCREEN

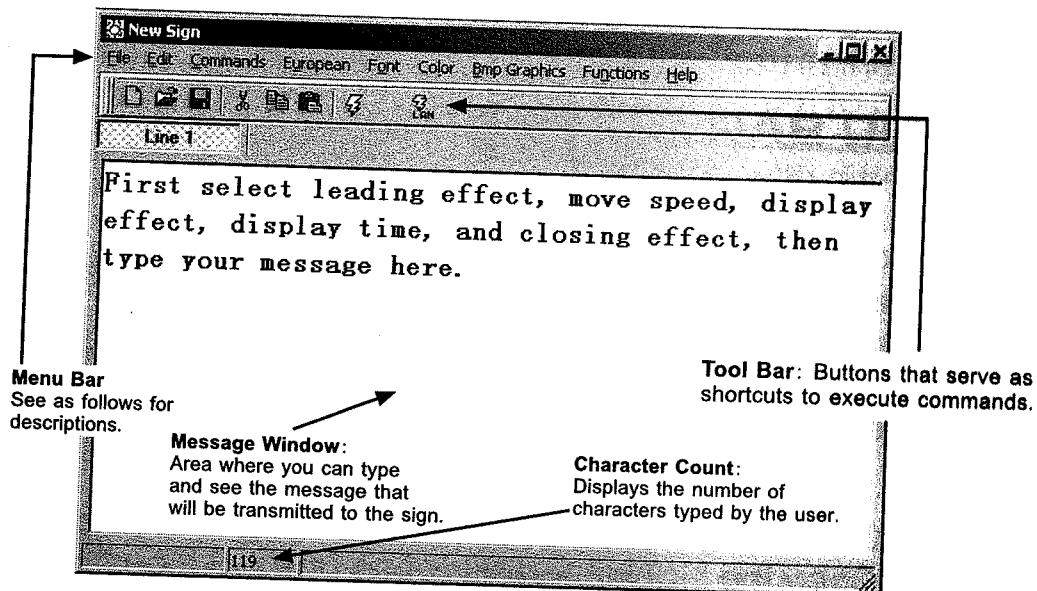

SET-UP





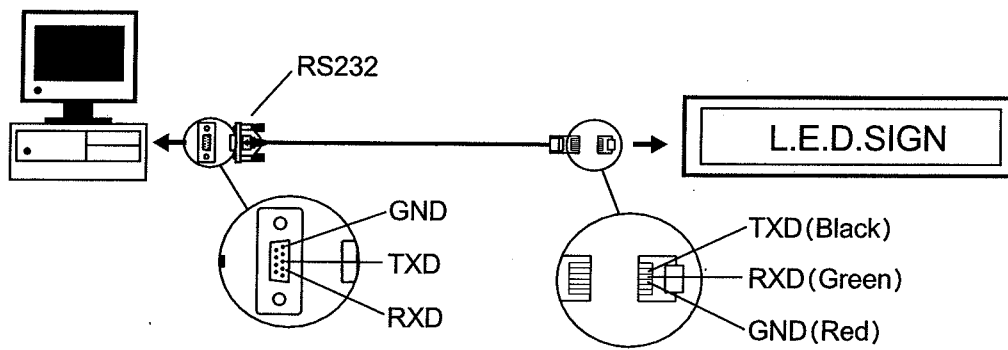



Connecting the cable

1. Connect the Phone Clip end of the Phone Type Cable to the sign.
2. On the back of your computer, identify a COM PORT. If you have trouble locating a COM PORT on your computer, please reference your computer user manual or contact the manufacturer of your computer.
3. Connect the 9-Pin connector end to the COM PORT you will be using. If the 9-pin connector is not connected to the correct COM PORT, computer communication to your sign will not work.



| | |
|-------|-------------|
| RS232 | PHONE JACK |
| PIN2 | RXD (Green) |
| PIN3 | TXD (Black) |
| PIN5 | GND (Red) |

Toolbar

-  Opens a new Message Window.
-  Opens an existing File.
-  Saves the current message in the Message Window.
-  Cut the highlighted selection and put it on the clipboard.
-  Copy the highlighted selection and put it on the clipboard.
-  Paste the contents of the clipboard.
-  Sends the message in the Message Window to the sign.
-  Sends the message through LAN.

THE MENU BAR

File

- New : opens a new window.
- Open : opens an existing file.
- Save : saves the file currently open.
- Set Comm : allows you to set the communication settings.
- Exit : exit the software program.

Edit

- Cut : Cut the highlighted selection and put it on the clipboard.
- Copy : Copy the highlighted selection and put it on the clipboard.
- Paste : Paste the contents of the clipboard onto the active document.
- Delete : Use this command to remove selected content from the Message Window.

Commands

- Leading : How the text will appear .
- Speed : Control the leading and closing moving speed
- Display effect : How the text will display.
- Display time : How long the message display.
- Closing : How the text will disappear .
- Special : Insert the TIME, DATE, a "BEEP".

European

Default European characters table for select.

| | | | | | | | | | |
|-------|-------|-------|-------|-------|-------|-------|-------|-------|-------|
| € U00 | ↑ U01 | ↓ U02 | U03 | † U04 | ‡ U05 | § U06 | ¶ U07 | ± U08 | ‡ U09 |
| ™ U0A | — U0B | † U0C | ‡ U0D | ¶ U0E | ■ U0F | ■ U10 | ¶ U11 | ¶ U12 | ■ U13 |
| α U14 | β U15 | Γ U16 | Π U17 | Σ U18 | σ U19 | μ U1A | τ U1B | ϖ U1C | ≈ U1D |
| Ω U1E | δ U1F | ∞ U20 | λ U21 | Ϛ U22 | £ U23 | ¥ U24 | ¥ U25 | → U26 | ← U27 |
| ¿ U28 | © U29 | ª U2A | ≥ U2B | € U2C | ∩ U2D | ⊗ U2E | œ U2F | š U30 | ± U31 |
| ² U32 | ³ U33 | ž U34 | ÿ U35 | ¶ U36 | œ U37 | š U38 | ‘ U39 | ° U3A | ≤ U3B |
| ¼ U3C | ½ U3D | ¾ U3E | ¿ U3F | À U40 | Á U41 | Â U42 | Ã U43 | Ä U44 | Å U45 |
| Æ U46 | Ç U47 | È U48 | É U49 | Ê U4A | Ë U4B | Ì U4C | Í U4D | Î U4E | Ï U4F |
| Ð U50 | Ñ U51 | Ò U52 | Ó U53 | Ô U54 | Õ U55 | Ö U56 | × U57 | Ø U58 | Ù U59 |
| Ú U5A | Û U5B | Ü U5C | Ý U5D | Þ U5E | ß U5F | à U60 | á U61 | â U62 | ã U63 |
| ä U64 | å U65 | æ U66 | ç U67 | è U68 | é U69 | ê U6A | ë U6B | ì U6C | í U6D |
| î U6E | ï U6F | ð U70 | ñ U71 | ò U72 | ó U73 | ô U74 | õ U75 | ö U76 | ÷ U77 |
| ø U78 | ù U79 | ú U7A | û U7B | ü U7C | ý U7D | þ U7E | ÿ U7F | | |

USER FONT MAKE

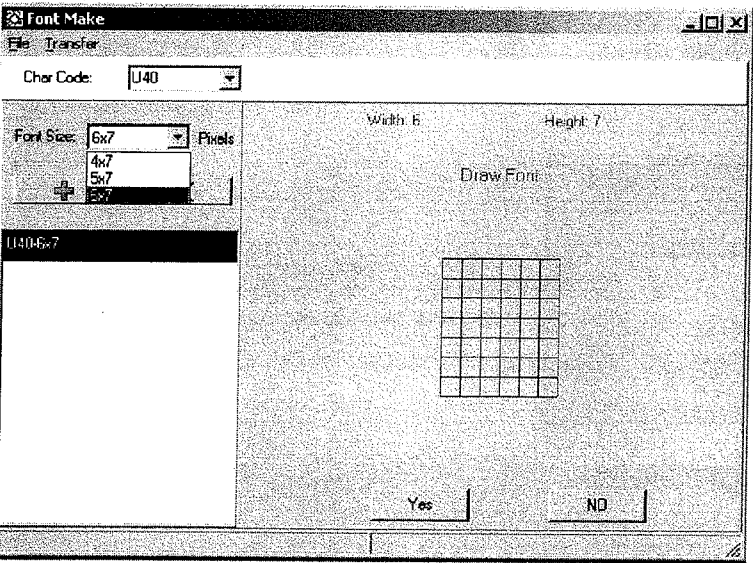

Select the char code where the character you will change, and then select font size. Click **+** to add the item in the list box. Then select this item to draw the font. Repeat the process for the same character with different font size, example : U40-4x7,U40-5x7,U40-6x7.

Click **Transfer|Transfer to Sign** to update the user font of the sign.

Click **File | Save Font** on this window to save a file.

RECALL DEFAULT FONT

Use for recall the above default European characters font to the Sign and software.

THE MENU BAR

Font
Select any one of font styles. European characters, or Greek symbols to be used in your message.

Colors Select any one of listed colors to use for your text.

Bmp Graphics

Edit Graphic... : Edit and save your own graphic images, and then insert into the message window refer graphic edit section

Function

Send Message : Send the current text in the Message Window to the LED Display Board. Before transferring, you should Select ID of Display Board (ID which you may set by "Set ID..." function). Simultaneously, Set which page you transfer to. There are 26 pages in all.

- Run Page : Run a specified page on the LED Display Board.
- Link pages To Run : Link some pages in order to Run more than one Page. For example, type in 'abc', the sign will display page A, page B, page C content consecutively.
- Set ID : Set ID of the Led Display Board .
Note: ID00 represents global call. If you have more than one sign, you might want to connect all the signs in a network, e.g. from ID01 to ID05 you can send message to any sign in the network by individual ID. To broadcast to all the signs, use ID 00.
- Set Clock : Set the Date and Time the Display Board system Clock.
- Delete Page : Delete a specified page information on the sign.
- Set Brightness : Set Display brightness, there are 4 levels of brightness.
- Display by Schedule : Schedule a message to be displayed.
you may make some pages display from sometime to another time. max can set up to 5 Schedule items one time.
- Delete page :Delete some pages in the running messages.
- Delete Schedule :Delete some items in Schedule table.
- Delete All :Delete all messages in the LED Display Board.
(Except system clock)

CONFIGURE SOFTWARE

1. Go to File and Set Communication

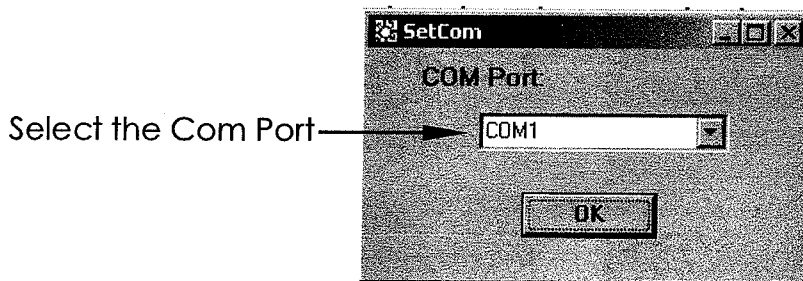

2. Click on OK when your settings are complete.

SENDING A MESSAGE

The Send Message icon is used to transmit the message to the sign.

1. In the Message Window, type in a test message such as 'Welcome to my message'.
2. Click on the icon on the Toolbar to bring up the Message window.

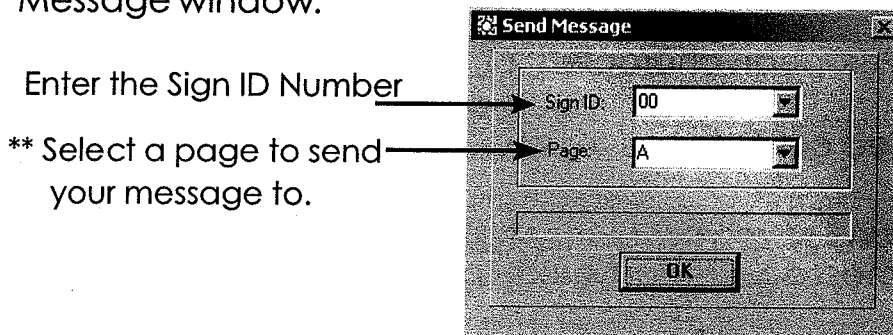

** You have pages A-Z available. Each page can be used to store a different message.

3. Click on OK to send your message to the sign. If your sign did not receive your message, try sending the message again.

BMP GRAPHIC EDITOR

Use the Graphic Editor to edit or create graphics of your own. To open the Edit Graphic window, click on **bmp Graphics** on the menu bar, then click on **Edit Graphics**

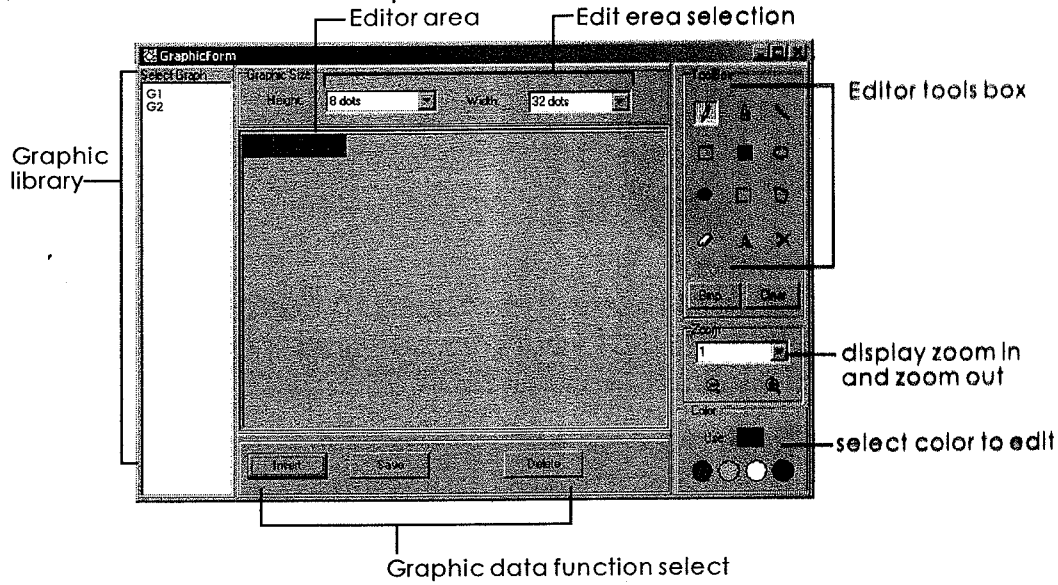

Select Graphic window

Click on any one of the graphics from the Select Graphic list to view the graphic in the Graphic window.

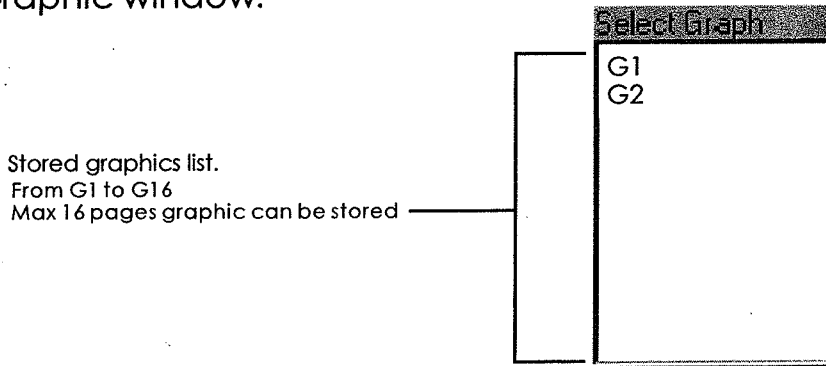

BMP GRAPHIC EDITOR

Color window

Select any one of four colors to edit an existing graphic or to create a graphic.

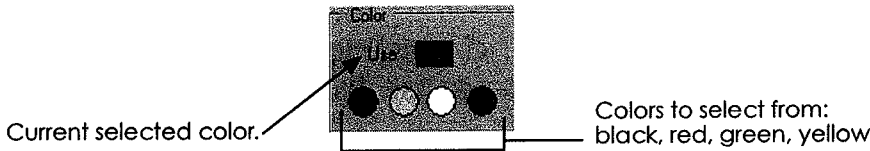

Edit graphic buttons

Functions of buttons are described below.











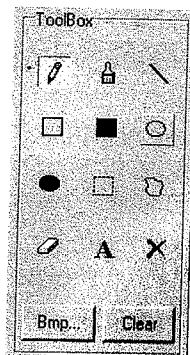



SAVE the current graphic displayed in the "Graphic" window. Graphic will be saved in the "Library".

DELETE a graphic from the "Library".

INSERT the current graphic in the "Graphic" window into your message.

Editor tools box



-  **Pen tool:** Click this tool, and move the mouse to Editor Area. Press and hold down the left button of your mouse, and move your mouse to free hand draw.
-  **Brush tool:** Click this tool, and move the mouse to Editor Area. Press and hold down the left button of your mouse and move your mouse to get brushing function.
-  **Line tool:** Click this tool. Move your cursor to select the starting point of the line. Then hold down the left button of your mouse, moving your mouse to the end point of the line. Then release mouse button.
-  **Outline rectangle tool:** Click this tool. To select the starting point by moving your cursor and hold down the left button of your mouse. Then move at the end and release mouse button.
-  **Rectangle tool:** Same operation step as outline rectangle tool.
-  **Outline ellipse tool:** Same operation step as outline rectangle tool.
-  **Ellipse tool:** Same operation step as outline rectangle tool.
-  **Pointer tool:** Click this tool. Select the edit area by press and hold down the left button of your mouse. Then the select area be round by release your mouse button. Moving the round area by hold down the left button of your mouse until the position you want. Then release the mouse button. Right click to fix the position.
-  **Polygon pointer tool:** Same operation step as pointer tool.
-  **Erase tool:** Click this tool. Just press and hold down the left button of your mouse and move your mouse to erase the area you want.
-  **Clear tool:** Click this tool and select the color. Then moving cursor to edit area left click your mouse. That the whole edit area will turn to that color. If you select black color, the whole edit area will be covered by black in color. Same as clear function.
-  **Text tool:** Click this tool. Move cursor to the starting point you want to put the text. Left click your mouse and text input will bring up. That you can type in your words or use windows cut and Paste function to input text. Then select the fonts and fonts size. Click OK Button to finish the text input. Then move the object to the position you want and right click your mouse to fix it.

Fonts and size indication

Text input area

Text preview

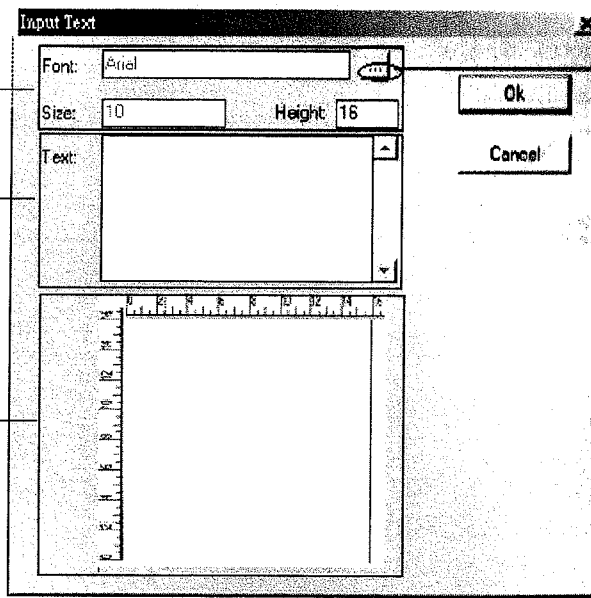

Click here to go to fonts selection

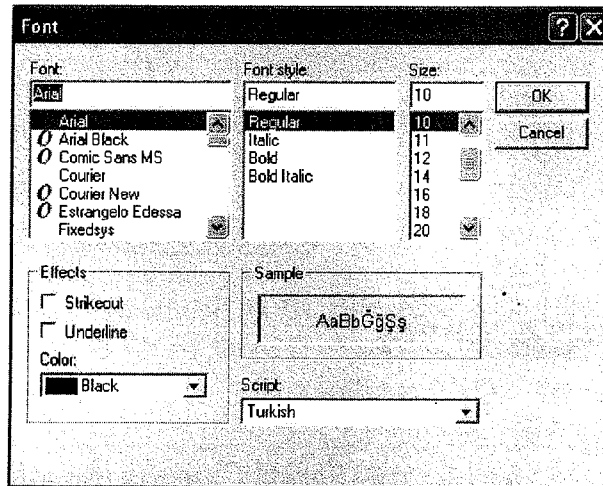
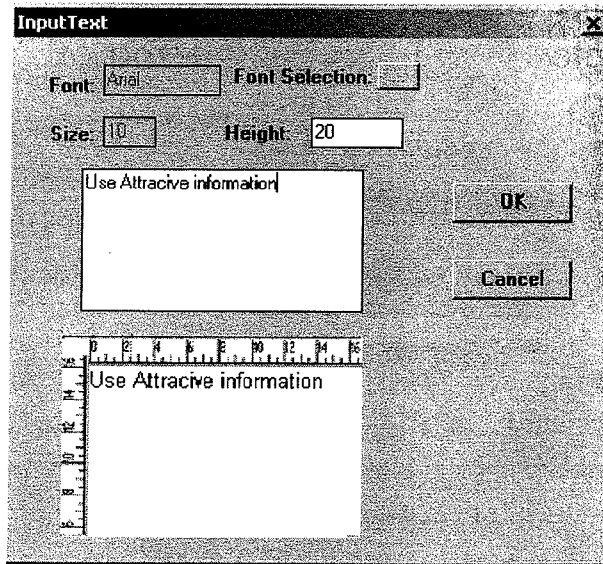

After clicking the Ok button in dialog box, move the rectangle area to proper position and right click the mouse to fix the information position.

Clear **Clear function key:** Left click this button to clear the whole edit area.

Bmp File **Bmp file function key:** Left click this button That can easily export the editing content to Bmp file, or import Bmp file edited by other program.

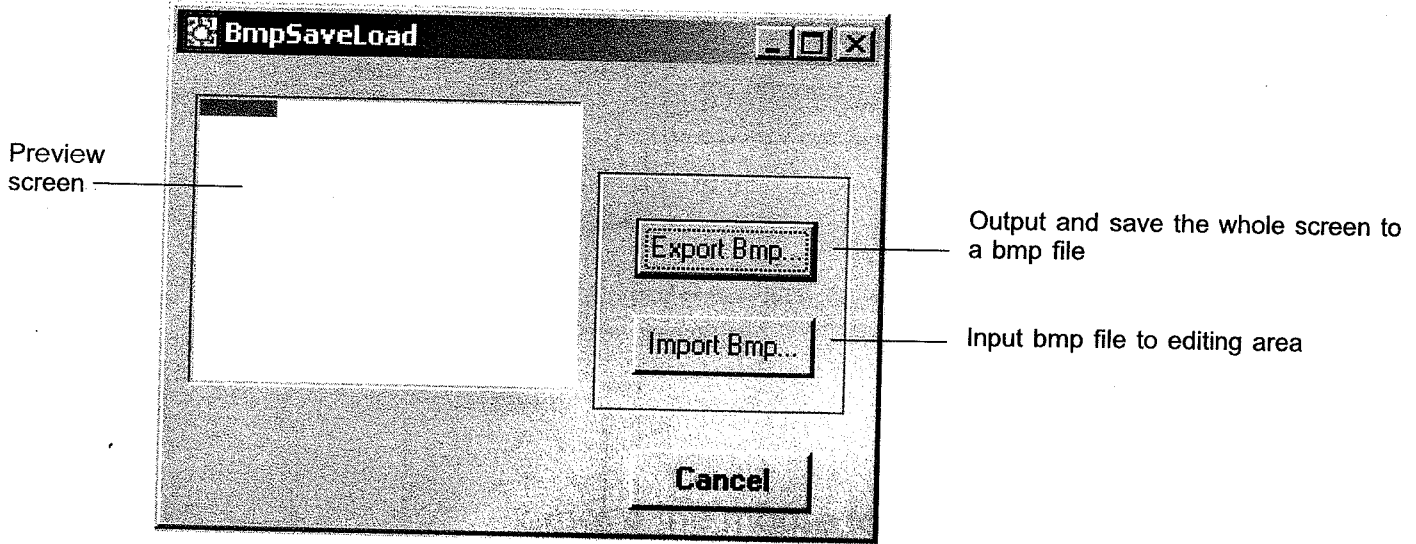

Display zoom in, zoom out function

The zoom size can be selected from 1 to 8. 1 is the smallest. You can zoom in or zoom out to affect your edit job as

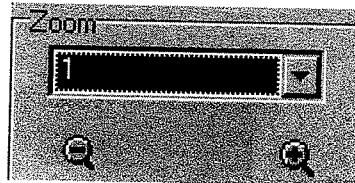

Color selection function

Just easily to left click the color button to select the color you want. If you edit a triple color frame, then you have four color boxes to select as. If you edit a single color frame, then you can select either red or black color box as

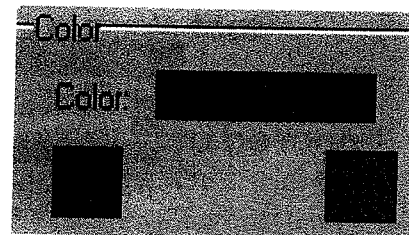
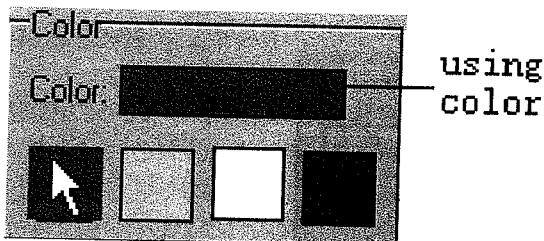

LAN COMMUNICATION

How it works

The display is first connected to the Serial Communication Port of a computer in the LAN environment which we refer to as the **R**eceiving **S**lave **C**omputer (**RSC**). The computer that will actually be transmitting messages to the display is referred to as the **T**ransmitting **M**aster **C**omputer (**TMC**). The **TMC** will have the display control software installed. It is not necessary to install the software on the **RSC**. The next step is to set-up a Generic/Text Only printer driver on the **RSC** and share it with the **TMC**. Once the set-up is done and a message created, a simple click on the button for "Send via Network" will bring up the "PRINT" dialog window. You then select the Generic/Text Only printer created and click on "OK" and your message is on its way.

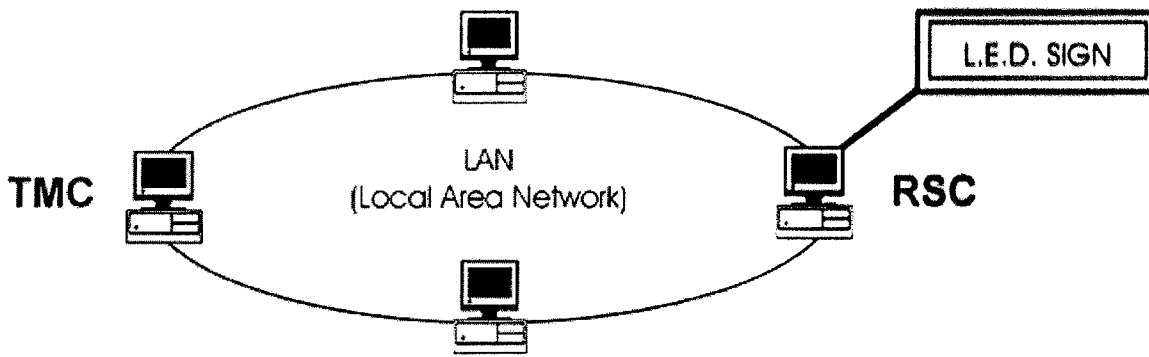

RSC Printer Driver Set-Up

1. Begin by clicking on " **Start** ", " **Settings** ", and " **Printer** ". The " **Printers** " dialog window will appear.
2. Double-click on the " **Add Printer** " icon. The " **Add Printer Wizard** " window will appear.
3. Click on " **Next** ". Select " **Local printer** " and click on " **Next** " again.
4. Under " **Manufacturers** ", search for " **Generic** ". Select " **Generic** " ON " **Next** ". If prompted: " **A driver is already installed for this printer** ", then select to " **Keep existing driver** " and click on " **Next** ".
5. Select the Communications Port on the **RSC** the display will be connected to and click on " **Next** ". For Example: If the display is connected to COM1, select " **COM** ".

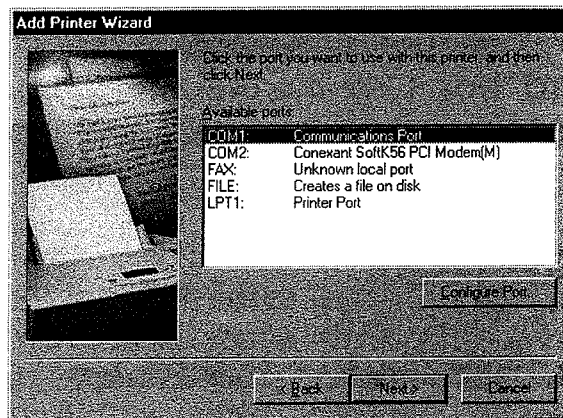

LAN COMMUNICATION

6. Under " **Printer name** ", type in the name you want for the Display Printer Driver. This name must be 12 characters in length. In the example below we used the initials " **F.D.** " to represent " **Front Desk** ". Select " **No** " to select the printer as the default printer and click on " **Next** ".

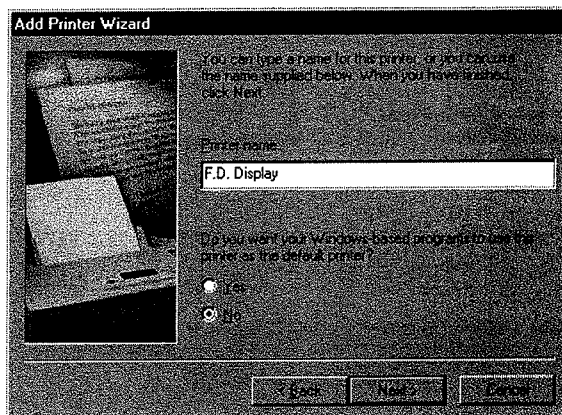

7. Click on "**Finish**" to complete the set-up. If prompted for the Windows 95 CD or disk, insert CD or disk into the proper drive and click "**OK**".
8. Now select the printer you created. Go to "**File**" and click on "**Properties**".
9. Click on the "**Details**" tab then click on "**Port Settings**".
10. Make sure the settings below are set accordingly. Click on "OK" when done.

Set to the "BAUD RATE" setting on PAGE 19.

Settings should be as shown.

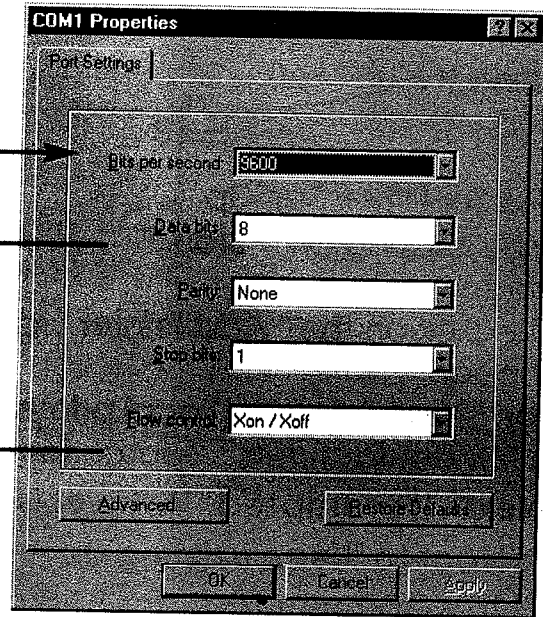

11. Click on the "**Sharing**" tab and click on "**Shared As**". In the "Share Name" box, type in the 12 character "**Printer name**" you used in step 6. If you want to "password protect" the use of the Display Printer Driver, type in a password in the "**Password**" box. Only the user with the password can access the "**Printer Driver**" to send a message to the display.
12. **RSC Printer Driver set-up complete**

LAN COMMUNICATION

TMC Printer Driver Set-Up

1. Click on "**Start**", "**Settings**", and "**Printer**". The "**Printers**" dialog window will appear.
2. Double-click on the "**Add Printer**" icon. The "**Add Printer Wizard**" window will appear.
3. Click on "**Next**". Select "**Network printer**" and click on "**Next**" again.
4. Select "**No**" to print from "**MS-DOS-based programs**". Click on "**Browse**".
5. Double-click on the name of the **RSC** on the network and select the Display Printer Driver created.

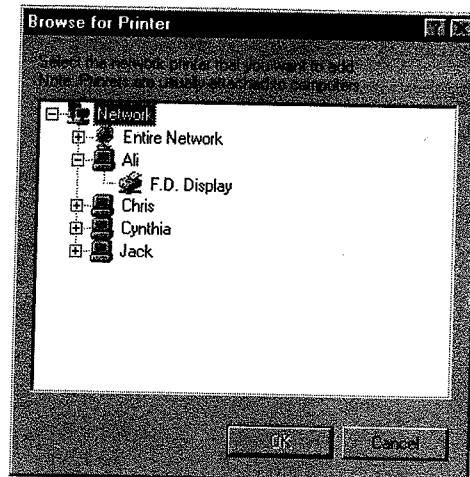

6. Click on "OK". Now click on "Next".
7. Under "Printer name", type in the 12 character "Printer name" used in Step 6 of the RSC Printer driver set-up.
8. Select "No" to select the printer as the default printer and click on "Next".
9. Click on "Finish" to complete the set-up. If prompted for the Windows 95 CD or disk, insert CD or disk into the proper drive and click "OK".
10. **TMC Printer Driver set -up complete**

SENDING A MESSAGE through the LAN

1. Start the TruColorII Software program. Create your message.
2. Click on "LAN" for "Send via Network". Input the "Sign ID Number" and "Page Number", Now click on "OK".
3. Select the Display Printer Driver from the Printer Name box and click on "OK". Message sent successfully!

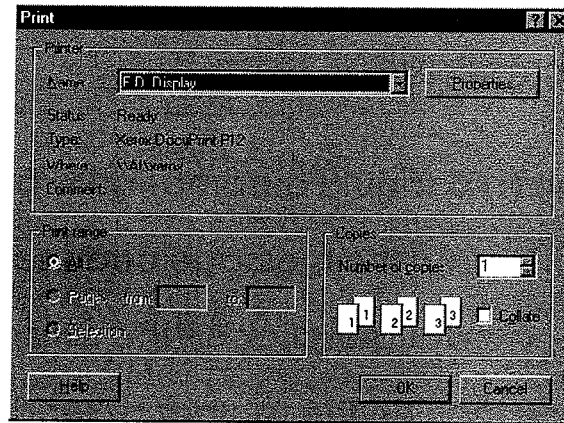

INTERNET E-MAIL COMMUNICATION

How it works

The display is first connected to the serial Communication Port of the computer at the remote location which we refer to as the **Receive Transmit Computer (RTC)**. The computer that will be transmitting the e-mail is referred to as the **Transmitting Master Computer (TMC)**. Both the **TMC** and **RTC** will have the display control software installed. The user at the **TMC** will create a message using the provided software and save it. Once the message is saved, the user can start the software program used to send e-mail (such as Microsoft Exchange, outlook, Eudora Pro, Netscape Mail etc) and attach the saved message file to the e-mail message and send it. The recipient at the **RTC** is then notified that new mail has arrived. The user can then open at attachment and send the message to the sign.

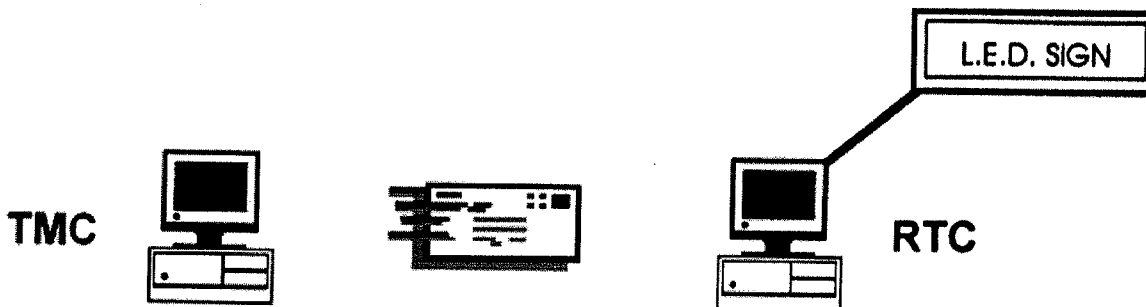

- Begin by installing the software program on the **TMC** and **RTC**.
- Configure the sign and software on the RTC.
- **TMC** instructions
 1. Start the software program on the TMC and create a message, Now save it and exit the program.

2. Start the software program used to send e-mail and select to send a new message.
3. Type in the "TO" address.
4. Now click on the icon that will allow you to attach a file. Select the file you want to be displayed in the sign.
5. your e-mail message should look similar to the following:

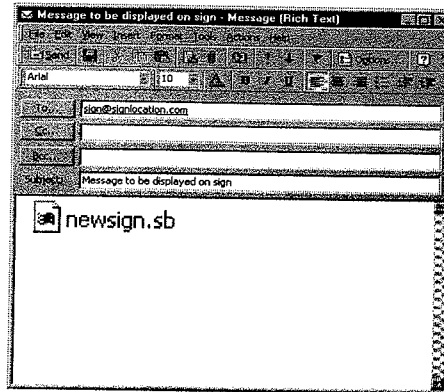

6. Now send the e-mail message.

• **RTC** instructions

1. The recipient at the **RTC** should automatically be notified when new m has arrived.
2. The recipient should open the message and see that the attached file for the sign.
3. The recipient can now double-click on the attached file and the program will start.
4. Now just click on the icon on the toolbar to send the message to the sig Your message is now being displayed.

! QUICK REFERENCE SECTION

Color Code Table

To select a COLOR, press **COLOR** once,

| Letter | Foreground Color | Background Color |
|--------|------------------|------------------|
| A | RED | BLACK |
| B | GREEN | BLACK |
| C | YELLOW | BLACK |
| D | BLACK | RED |
| E | BLACK | GREEN |
| F | BLACK | YELLOW |
| G | RED | GREEN |
| H | GREEN | RED |
| I | R/Y/G | BLACK |
| J | RANDOM | BLACK |

! QUICK REFERENCE SECTION

Font size table

To select a FONT SIZE, press **FONT** to toggle between the fonts listed below.

| Letter | Character Font Size |
|--------|---------------------|
| A | NORMAL |
| B | BOLD |
| C | ITALIC |
| D | Narrow |
| E | High |
| F | Big |

European Character Table

To display a EUROPEAN CHARACTER, press the Corresponding Letter, then press the **EUROP-CHAR** key until the European letter of your choice is reached. Once you see the European letter you which to use, press any other letter to continue to type your message.

| Letter in Upper "PPER CASE" | Foreground Color |
|-----------------------------|------------------|
| A | Ã Â Á À Ä Å Æ |
| B | ß |
| C | Ç |
| D | Ð |
| E | É Ê È Ë |
| I | Í Î Ï |
| N | Ñ |
| O | Ó Ô Ò Ö Õ Ø |
| P | þ |
| U | Ú Û Ü |
| Y | Ý ÿ |

| Letter in Lower "OWER CASE" | Foreground Color |
|-----------------------------|------------------|
| a | ã â á à ä å æ |
| c | ç |
| e | é ê è ë |
| i | í î ï |
| n | ñ |
| o | ó ô ò ö õ ø |
| p | þ |
| u | ú ù ü |
| y | ÿ ÿ |

! QUICK REFERENCE SECTION

Special effects table

After you complete message editing, you can select the leading and closing effect by and key and confirm by enter key.

| Letter | Type | Effet | Description |
|--------|------|-----------|------------------------------------|
| A | L, T | Immediate | Image will be immediately appeared |

| | | | |
|---|------|--------------|---|
| B | L, T | Xopen | Image will be shown from center and extend to 4 side |
| C | L, T | Curtain UP | Image will be shown one line by one line from bottom to top |
| D | L, T | Curtain Down | Image will be shown one line by one line from Top to Bottom |
| E | L, T | Scroll Left | Image will be scrolled from Right to Left |
| F | L, T | Scroll Right | Image will be scrolled from Right to Left |
| G | L, T | Vopen | Image will be shown from center to top and Bottom one line by one line |
| H | L, T | Vclose | Image will be shown from Top and Bottom to Center one line by one line |
| I | L, T | Scroll Up | Image will be scroll from Bottom to Top |
| J | L, T | Scroll Down | Image will be scrolled from Bottom to Top |
| K | L, T | Hold | Previous Screen will be kept |
| L | L | Snow | Pixels will be dropped down from top and stack up to build the image |
| M | L | Twinkle | a blank diagonal line will be scrolling on the image |
| N | L | Block Move | 8 pixel width display block will be moved from right to left one by one |
| P | L | Random | Random Pixel will be appeared to build the image |
| Q | L | Pen writing | Hello World |
| R | L | Pen writing | Welcome |

L = Leading commands - how the text will appear.
T = Closing commands - how the text will disappear.

Display effect

- A Normal
- B Blinking
- C Play song 1
- D Play song 2
- E Play song 31

Moving speed

- A Fast
- B Medium 1
- C Medium 2
- D Slow

Bell duration

- A Short
- B Medium 1
- C Medium 2
- D Long

Display time

0.5sec - 25 sec

Date display format

DD/MM/YY

Time display format

hh/mm

② **HELP SECTION - IR (Infrared Remote Keyboard)** **Most Commonly Asked Questions**

Can I run multiple pages when the SCHEDULE DISPLAY.

Yes, you can refer "page 8-adding schedule setting.

HOW CAN I CONTROL MORE THAN ONE SIGN FROM A CENTRAL LOCATION?

Set the different ID address. software will allow you to control up to 255 signs by setting.

How do I remove the demo message on the sign?

The demo message is permanently programmed onto the sign and is designed to run automatically when there are no messages programmed by the user. When you program a message onto a page, the demo message will no longer show.

How much text can I program onto each PAGE?

You can program up to 250 characters per page. there 26 pages text message and 16 pages graphic can be programmed.

Will I lose my messages if I remove the power to the sign?

No, there is a built-in battery in the sign.

After I unplug my sign, I lose the current TIME and DATE setting. Why?

The battery on the cpu board is gone. you should replace with same battery. The battery normally can keep 2 years.

How do I display lower-case letters?

Please refer to page 5 **SHIFT** key function.

I plugged the sign in but nothing comes ON?

Unplug the power to the sign and plug it in again.

Make sure the power adaptor plug is plugged into the sign and AC connect firmly. Try using another wall outlet. Refer page 8 resetting system using the **FUNCT** key.

② **HELP SECTION - SOFTWARE** **Most Commonly Asked Questions**

How do I turn my sign OFF and ON automatically everyday.

Please refer page 15 under the function control display by schedule.

Trouble Shooting

My sign does not show after setting schedule display.

Clear the schedule display and reset the system.

Refer page 15 resetting system using the **DELECT** all.

② HELP SECTION - SOFTWARE

Troubleshooting

The software is not communicating with the sign?

Use the checklist below to verify your settings.

- I have found the ID setting of the sign and entered them into the software. **Page 15.**
- I am using the cable supplied by. **Page 13.**

NOTE: The cable may not be extended with any other cable. The cable must be one complete cable from the 9-Pin connector to the sign.

"OPEN COM ERROR"

If the error message is "OPEN COM ERROR", this means the Com Port you have selected is not available for your use or is being used by an internal device in your computer. A computer normally has 4 COM PORTS. Two external ports which are available to connect external devices to the computer and two Internal ports which are available, in most cases, for computer use only. Please check the back of your computer to see if it is labeled COM1 or COM2. If not, please refer to your computer user's manual or contact the computer manufacturer for more information.

My laptop does not have any Com Ports and only has support for USB devices.

Some newer laptops do not have Com Ports and only support USB devices (please reference your Laptop User's Manual to verify this). For this situation you will need to purchase a **USB Serial Adapter** directly from or from your local computer store. This device will convert one of your Available USB ports to a working Com Port **does not guarantee that this device will work with all laptops due to other devices installed by user and varying manufacturers equipment.** Please contact the manufacturers support center directly for questions regarding installation operation.

Inspect Items

The following items should be inside the packing carton:

- Hardware installation manual



- Software

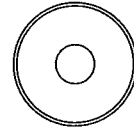

- User manual

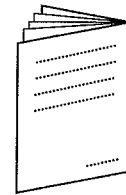

- Main LED display board

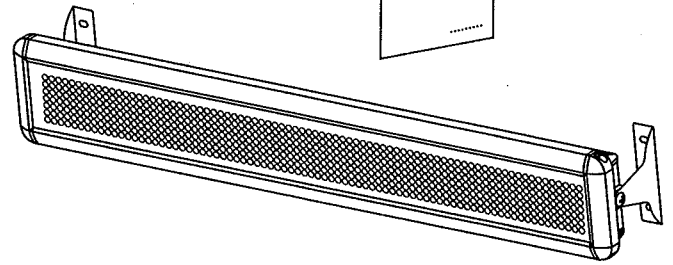

- RS232 cable



- Main LED display board power adaptor

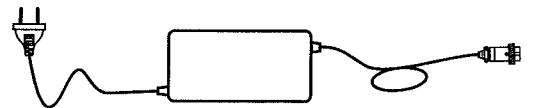

- Mounting brackets

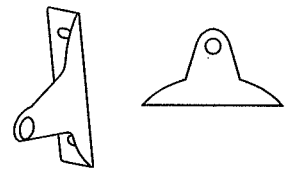

- Remote keyboard

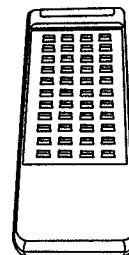

Notify the carrier if there is damage. Please fill out the warranty registration form to obtain warranty coverage.

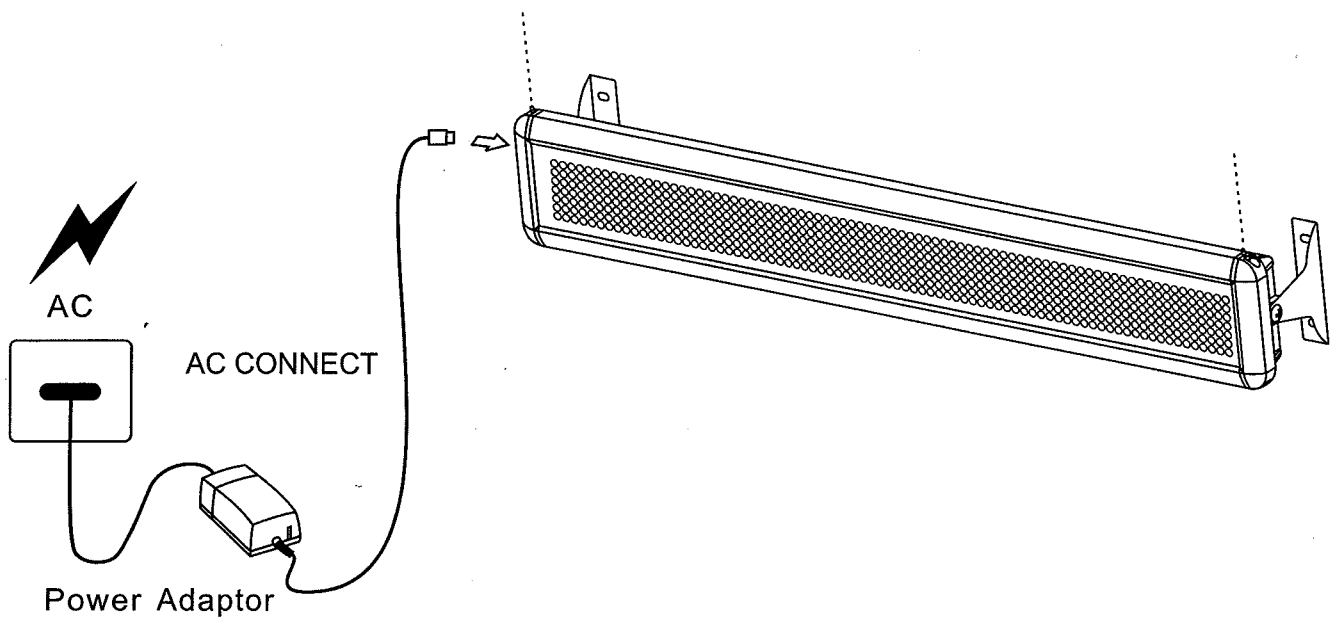

INSTALLATION AND SET UP

1. Mount the brackets onto the chosen wall location. Use the mounting screws included with the display to fasten the brackets onto the sign.
2. There are two wires from the power adaptor. First connect the two-prong end to any AC wall outlet. Second, connect the single prong end to the display via the location on the end cap.
3. As soon as you connect the single prong end to the sign, the sign should automatically light up and start displaying the "demo" message that is a preprogrammed message showing all the features of the display. Note : If your sign does not turn "ON", please turn to the user manual Help Section on page 26.
4. Surge protectors are recommended if you are in an area where power outages are frequent.

