

15. Disposal :

Please disposal of the unserviceable device according to the current statutory requirements.

16. Specification :

Voltage : 100/240Vac, 50/60Hz	DMX Channels : 8
Fuse : 2A Slow blow	Dimensions : 220 x 176 x 99mm
Laser Class : 3B 	Power Consumption : 15W
Laser Power : 40mW Green, 100mW Red	Weight : 1.6kg

Note: Conforms to Laser and LED Safety standard BSEN60825-1:2007 incorporating corrigendum 2008

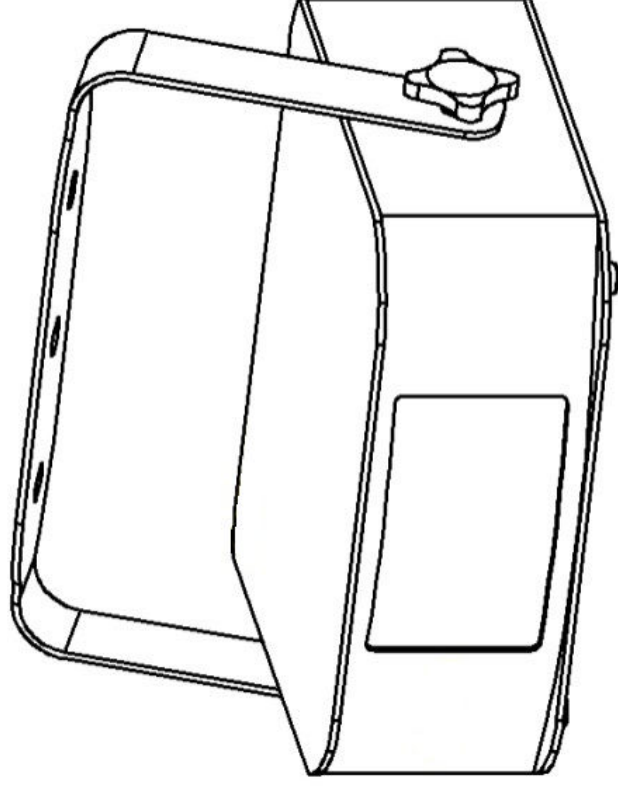

LS-Plasma Laser

User manual**152.745UK**

Version 1.0

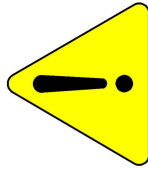

CAUTION

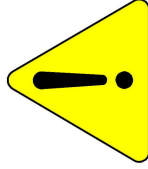

- Please read this manual fully before installing or operating this product as it contains important safety information relating to its installation and operation.
- This Class 3B  laser product emits hazardous levels of optical radiation and will cause injury to the eyes if viewed directly.
- This product is not suitable for projection directly at audiences or other personnel.
- This product must not be used for any form of audience scanning application and is for professional use only.

1.1. Rear display:

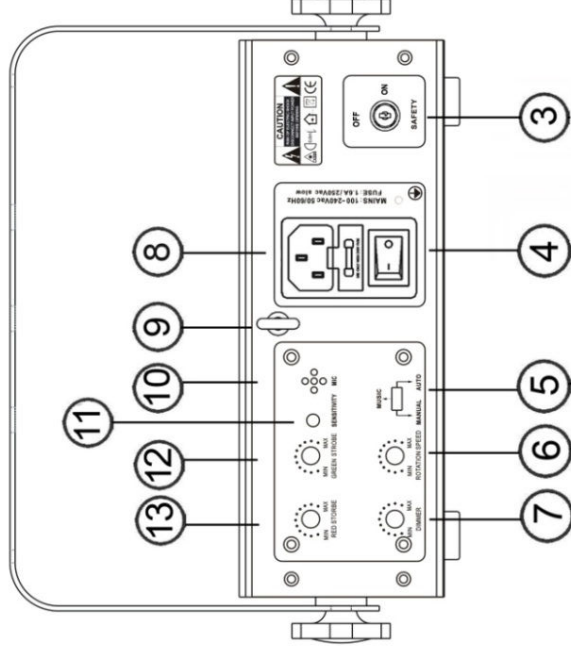

- Safety Key
- Power ON/OFF Switch
- Manual, Auto, Sound to light mode
- Laser Rotate Speed
- LED Light Dimmer
- IEC Power IN
- Safety Hook
- Microphone
- Sound Sensitivity
- Green Laser Strobe
- Red Laser Strobe

10. Layout:

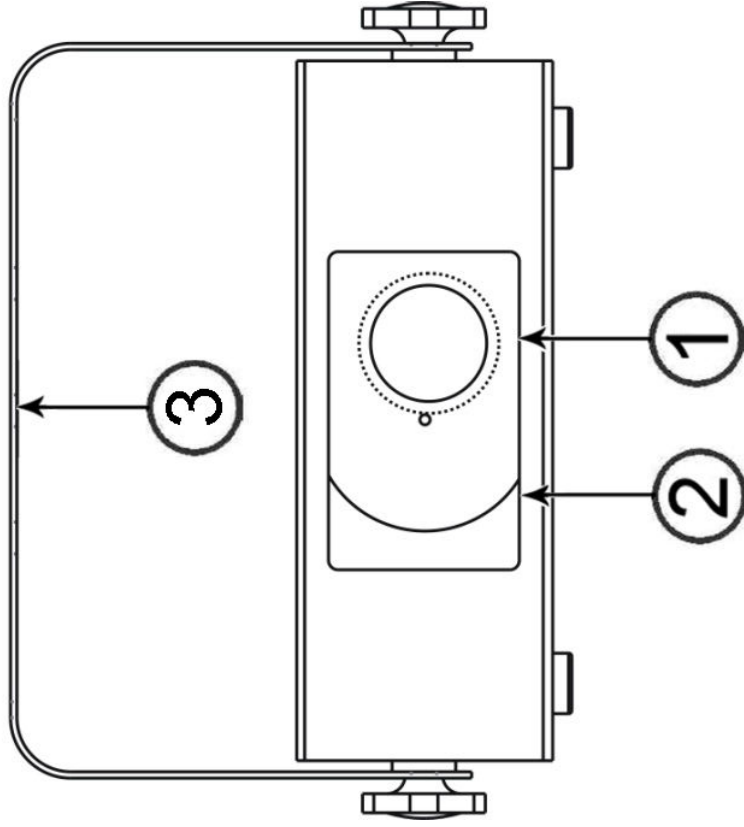

- 1. LED Aperture
- 2. Laser Aperture
- 3. Mounting Bracket

1. Introduction:



This Class 3B laser product should only be installed and used by personal who are trained in the management of laser radiation and are able to operate in accordance within the guidance given by the Health and Safety Executive (HSE) in HS(G)95: "The Radiation Safety of Lasers used for Display purposes".

Copies of this guide can be downloaded from the HSE website below:

www.hse.gov.uk/pubns/priced/hsg95.pdf

This product contains no user-serviceable parts. Under no circumstances should any attempt be made by the user to dismantle or modify it in any way.

2. Installation and mounting instructions:

This product must be securely mounted so that its emission is always directed away from people and objects that are able to reflect the emission towards people. In this regard the separation distances of 3 metres vertically and 2.5 metres horizontally, cited in HS(G)95 and shown overleaf must be observed.

Venue cross-sectional view

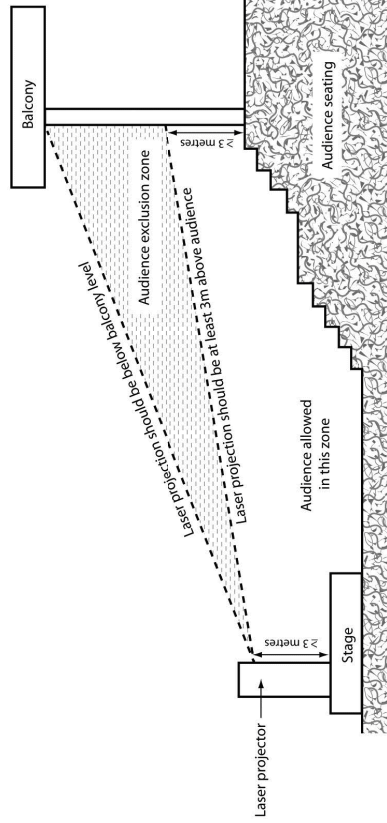

Venue birds eye view

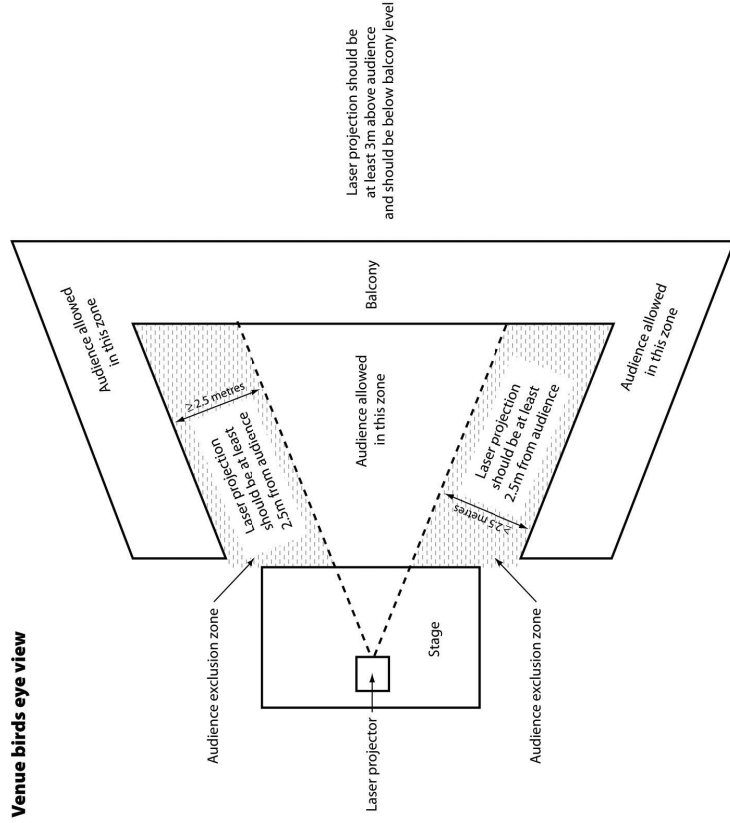

8. General maintenance:

Be sure to power off the fixture before conducting maintenance.

To maintain optimum performance and minimize wear, fixtures should be cleaned frequently. Usage and environment are contributing factors in determining frequency. As a general rule, fixtures should be cleaned at least twice a month. Dust build-up reduces can reduce light output & performance as well as overheating. This can lead to reduced life and increased mechanical wear.

Unplug fixture from power. Use a vacuum or air compressor and a soft brush to remove dust collected on external vents and internal components. Clean all glass when fixture is cold with a mild solution to the cloth or tissue, and drag dirt and grime to the outside of the lens. Gently polish optical surfaces until they are free of haze and lint.

The cleaning of internal and external optical lenses and/or mirrors must be carried out periodically to optimize light output. Cleaning frequently depends on the environment in which the fixture operates: damp, smoky or particularly dirty surroundings can require cleaning fluid. Always dry the parts carefully. Clean the external optics at least every 20 days.

9. Quick trouble shooting :

7.1 If the unit does not function – Check that the main power is on and the fuse is intact.

7.2 If the unit is not reacting to music – check the unit is in “sound to light” mode and that the sensitivity control is fully clockwise.

7.3 If the product is not reacting to DMX signals, check the cables and connections

7. Caution:

For your safety, please kindly pay attention to all of the warnings below:

- Always plug in the power plug last and disconnect from the mains when the device is not in use or before cleaning.
- Do not install and operate the device in rain or extreme heat, moisture or dusty environments.
- This device is for indoor use only and in a dry environment.
- Do not switch on immediately. Wait until the unit reaches room temperature.
- Do not shake the device and avoid brute force when installing or operating
- Do not use the device during thunderstorms and please disconnect the power.
- Do not use solvents or aggressive detergent to clean the device. Use a soft and clean cloth.
- Do not modify the device or the connected power cord without authorization.
- Do not stare into the aperture. This product emits hazardous levels of optical radiation and will cause serious injury to the eyes if viewed at close range.
- This product should be securely mounted so that its output emission is always directed away from people and at objects that are able to reflect emission towards people. In this regard, the separation distances cited in HS(G)95 should be observed.

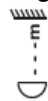
- The symbol  determines the minimum distance from lighted objects. The minimum distance between light-output and the illuminated surface must be more than 0.5m.

Always allow enough room for adequate ventilation. It is important never to obstruct the fan or air-vents

The product must be fixed to suitable rigging using an appropriate clamp and the fixing screws tightened to prevent the fixture from moving. A suitable safety cable should also be used.

When selecting the installation location, take into account the need for routine maintenance and also make sure that there is no possibility of any unauthorized persons interfering with the installation. Never install in locations where the product could be exposed to rain, high humidity, extreme temperatures, or restricted ventilation. Also ensure that the laser is located a minimum of 0.5metres from any potentially flammable materials

LS-PLASMA LASER: For indoor use only**3. General introduction:**

This first of a kind laser takes a red and green laser beams and diffracts the light through a patented lens to produce a unique plasma type effect, which rotates and changes pattern constantly as a speed which you set. This effect can be further enhanced by the 5W blue LED and is best viewed on a ceiling or flat wall to create the desired atmosphere.

Features :

- Red and green lasers
- 5W blue LED
- Unique rotating plasma pattern effect
- Manually controller speed, brightness and strobe.
- 3 modes of operation: Manual, Auto and Sound to light
- Key controlled for laser emission safety

4. Packaging contents:

Please check the contents to ensure that the product has been received in good condition.

Laser x 1unit	User's Guide x 1pc
IEC Power Lead x 1pc	Interlock Connector x 1pcs
Safety Keys x 2pcs	

If you find any accessory is missing or the lighting has arrived with any problems, please contact your local dealer at once. This product contains no user-serviceable parts so make no attempt to try to fix or modify this item yourself as this will invalidate the warranty. We recommend you keep the original package and proof of purchase for any possible replacement or returned demand.

5. Connect with power supply:

Use the plug to connect to the main power supply as following.

Line	Connection	International signal
Brown	Live	L
Blue	Neutral	N
Yellow /Green	Earth	E

6. Replacing fuse :

Disconnect from the main power supply first, then remove the fuse from the IEC Socket or fuse holder . Replace with a fuse of the correct rating as stated on product label or user guide.