

**15. Disposal :**

Please disposal of the unserviceable device according to the current statutory requirements.

**16. Specification :**

<b>Voltage :</b> 100/240Vac, 50/60Hz	<b>DMX Channels :</b> 11
<b>Fuse :</b> 2A Slow blow	<b>Dimensions :</b> 250 x 175 x 110mm
<b>Laser Class :</b> 3B	<b>Power Consumption :</b> 25W
<b>Laser Power :</b> 40mW Green, 80mW Red	<b>Weight :</b> 2.6kg

Note: Conforms to Laser and LED Safety standard BSEN60825-1:2007 incorporating corrigendum 2008

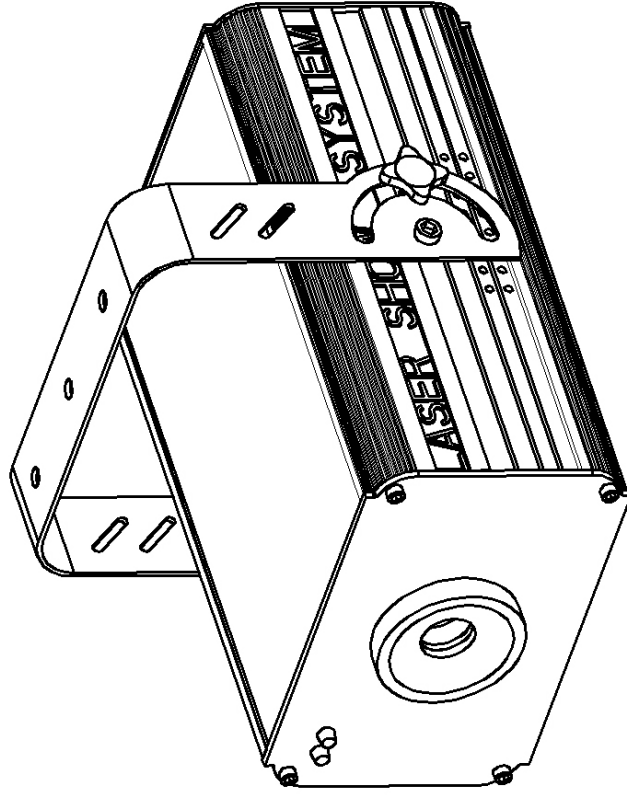

# LS-01 Laser

User manual

152.564UK

Version 2.0

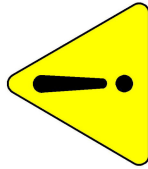

# CAUTION

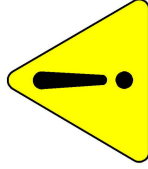

- Please read this manual fully before installing or operating this product as it contains important safety information relating to its installation and operation.
- **This Class 3B  laser product emits hazardous levels of optical radiation and will cause injury to the eyes if viewed directly.**
- **This product is not suitable for projection directly at audiences or other personnel.**
- **This product must not be used for any form of audience scanning application and is for professional use only.**

6 (Rotation Speed)	000-255	Rotating Speed (Slow to Fast)
7 (Rotation Direction)	000-075	Clockwise Rotation
	076-150	Stop
	151-255	Anti-clockwise Rotation
8 (Liberating Range)	000-255	Librating Range
9 (Liberating Mode)	000-056	LIBRATING Mode 1
	057-112	LIBRATING Mode 2
	113-168	LIBRATING Mode 3
	169-255	LIBRATING Mode 4
10 (COLOUR)	000-028	Red & Green (NOTE: No function in Ch 11)
	029-056	Green (NOTE: No function in Ch 11)
	057-084	Red (NOTE: No function in Ch 11)
	085-112	Red Off, Strobe Green
	113-140	Green Off, Strobe Red
	141-168	Red On, Strobe Green
	169-197	Green On, Strobe Red
	198-224	Both Red and Green Strobe
11 (Strobe)	225-255	Alternately Strobe Red & Green
	000-255	Slow to Fast

**14. DMX controlling :**

DMX CHANNEL	DMX VALUE	DESCRIPTION
	000-019	Laser Block Out
	020-039	ARA, Auto Running Random Effect
	040-059	SRA, Sound Activated Random Effect
	060-079	SLP, Slow Moving Patterns Effect
	080-099	FAP, Fast Moving Patterns Effect
	100-119	SOP, Sound Activated Moving Patterns Effect
<b>1 (Mode)</b>	120-139	SLL, Slow Moving Lines Effect
	140-159	FAL, Fast Moving Lines Effect
	160-179	SOL, Sound Activated Moving Lines Effect
	080-199	SLD, Slow Moving Dots Effect
	200-219	FAD, Fast Moving Dots Effect
	220-239	SOD, Sound Activated Moving Dots Effect
	251-255	DMX MODE (Other channels active)
		000-255
<b>2 (Rotation Speed)</b>	000-075	Clockwise Rotation
	076-150	Stop
<b>3 (Rotation Speed)</b>	151-255	Anti-clockwise Rotation
	000-255	Librating Range Low to high
<b>4 (Librating Range)</b>	000-056	LIBRATING Mode 1
	057-112	LIBRATING Mode 2
<b>5 (Librating Mode)</b>	113-168	LIBRATING Mode 3
	169-255	LIBRATING Mode 4

**1. Introduction:**

This Class 3B laser product should only be installed and used by personal who are trained in the management of laser radiation and are able to operate in accordance within the guidance given by the Health and Safety Executive (HSE) in HS(G)95: "The Radiation Safety of Lasers used for Display purposes".

Copies of this guide can be downloaded from the HSE website below:

[www.hse.gov.uk/pubns/priced/hsg95.pdf](http://www.hse.gov.uk/pubns/priced/hsg95.pdf)

This product contains no user-serviceable parts. Under no circumstances should any attempt be made by the user to dismantle or modify it in any way.

**2. Installation and mounting instructions:**

This product must be securely mounted so that its emission is always directed away from people and objects that are able to reflect the emission towards people. In this regard the separation distances of 3 metres vertically and 2.5 metres horizontally, cited in HS(G)95 and shown overleaf must be observed.

Venue cross-sectional view

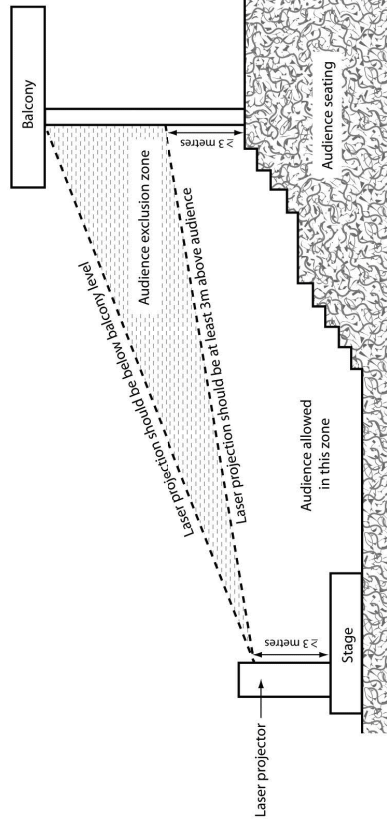

13. DMX-512 connection :

The fixture is equipped with 3-pin XLR connectors for DMX input and output. The SE connectors are wired in parallel. Only use a shielded twisted-pair cable designed for 3-pin XLR-plugs and connectors in order to connect the controller with the fixture or one fixture with another.

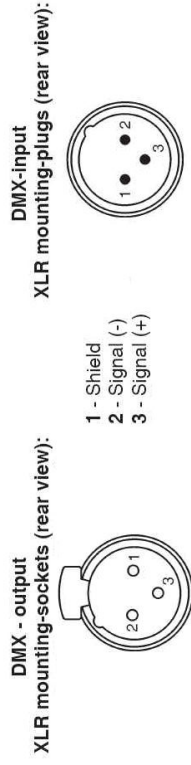

Venue birds eye view

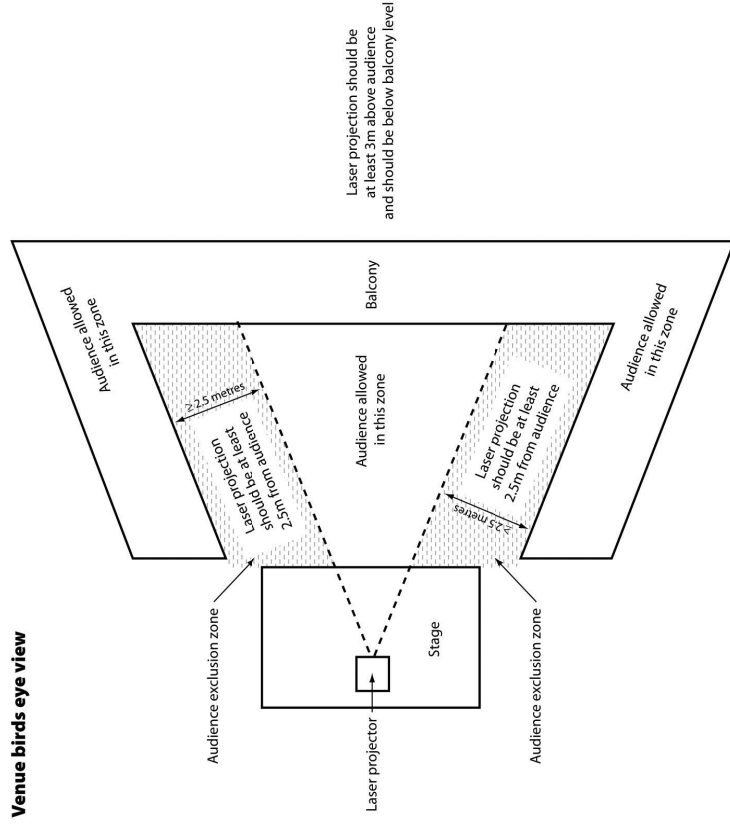

Building a serial DMX-chain :

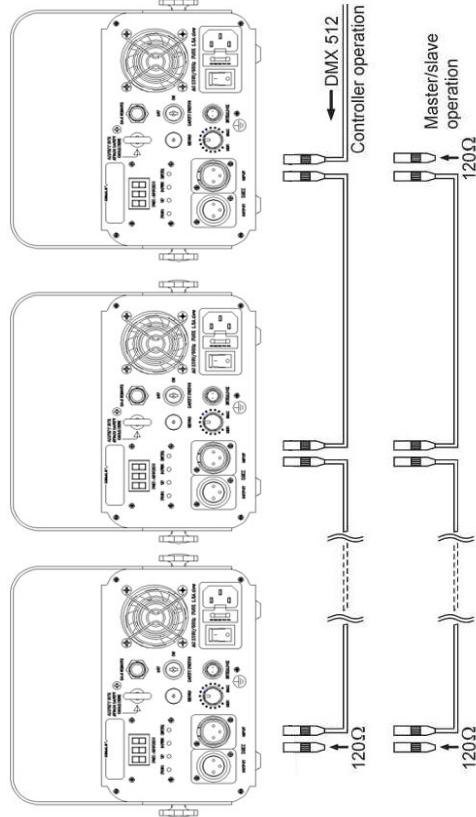

**Caution:** At the last fixture, the DMX-cable has to end with a terminator. Solder a 120 Ohm resistor between PIN 2 (-) and PIN 3 (+) into a 3-pin XLR-plug and plug it in the DMX-output of the last fixture.

**12. Functions guide:**

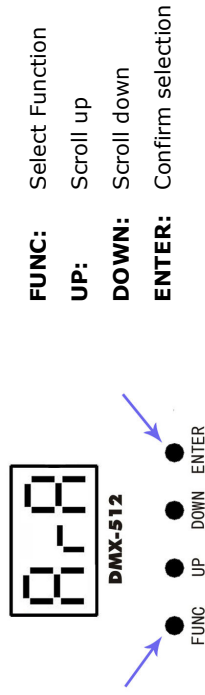

DISPLAY	STAND ALONE MODE PREPROGRAM EFFECT
A-rA	Auto Running Random Effect
S-rA	Sound Activated Random Effect
S-lP	Slow Moving Patterns Effect
F-rP	Fast Moving Patterns Effect
S-oP	Sound Activated Moving Patterns Effect
S-lL	Slow Moving Lines Effect
F-rL	Fast Moving Lines Effect
S-oL	Sound Activated Moving Lines Effect
S-lD	Slow Moving Dots Effect
F-rD	Fast Moving Dots Effect
S-oD	Sound Activated Moving Dots Effect
001	DMX Address

Always allow enough room for adequate ventilation. It is important never to obstruct the fan or air-vents

The product must be fixed to suitable rigging using an appropriate clamp and the fixing screws tightened to prevent the fixture from moving. A suitable safety cable should also be used.

When selecting the installation location, take into account the need for routine maintenance and also make sure that there is no possibility of any unauthorized persons interfering with the installation. Never install in locations where the product could be exposed to rain, high humidity, extreme temperatures, or restricted ventilation. Also ensure that the laser is located a minimum of 0.5metres from any potentially flammable materials

**LS01 LASER: For indoor use only****3. General introduction:**

This high quality unit with red and green lasers gives an effect similar to one when a light is shone on a mirror ball generating thousands of laser points. It can create light wall, light tunnel and cloud sea effects when used with a fogger/smoke machine. Its 11 DMX channels and sound activation make this unit ideal for disco, bars and night clubs.

**Features :**

- 11 DMX channels program/sound, rotation speed, rotation direction, image size, effect speed, colour, strobe
- Can be operated by a universal DMX controller (such as 154.059 - not supplied)
- 11 stand alone modes of operation
- Key control for laser emission with added security of remote switching facility
- Sound activated with sensitivity control
- Fan cooled
- 2 motors for multiple effects
- Master/slave mode

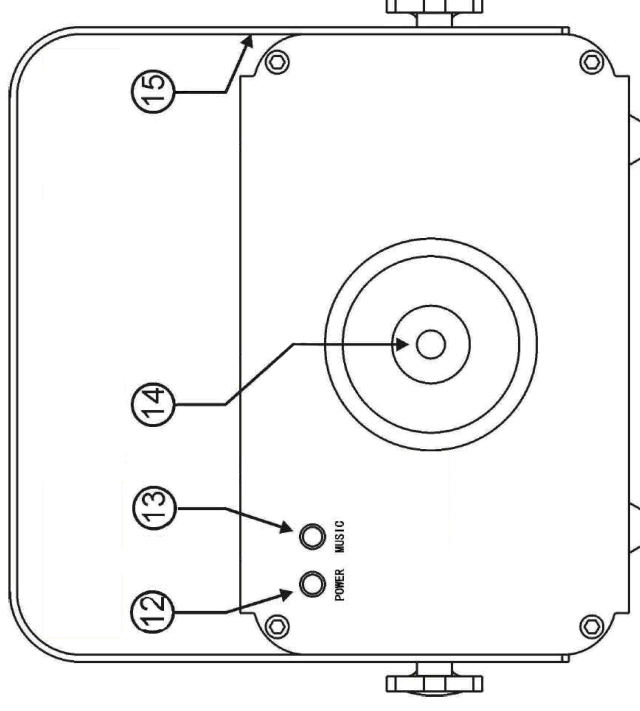
**1.1. Layout:**

- 12. Power on indicator
- 13. Warning label
- 14. Music detector
- 15. Laser output point (Lens)

**10. Rear display:**

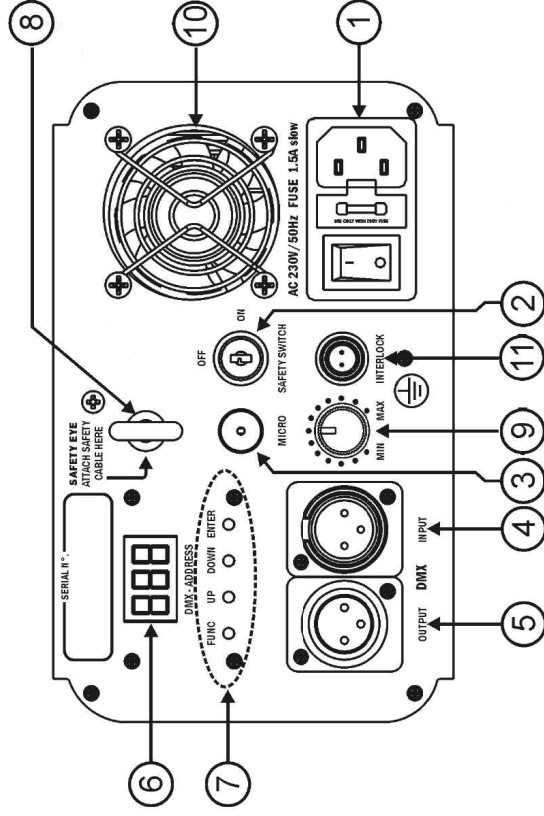

1. IEC Power input
2. Safety Key
3. Microphone
4. DMX Input
5. DMX Output
6. Digital control display
7. Function buttons (see section X)
8. Safety Hook
9. Sound sensitivity control
10. Cooling Fan
11. Interlock input (For emergency stop button)

**4. Packaging contents:**

Please check the contents to ensure that the product has been received in good condition.

Laser x 1unit	User's Guide x 1pc
IEC Power Lead x 1pc	Interlock Connector x 1pcs
Safety Keys x 2pcs	

If you find any accessory is missing or the lighting has arrived with any problems, please contact your local dealer at once. This product contains no user-serviceable parts so make no attempt to try to fix or modify this item yourself as this will invalidate the warranty. We recommend you keep the original package and proof of purchase for any possible replacement or returned demand.

**5. Connect with power supply:**

Use the plug to connect to the main power supply as following.

Line	Connection	International signal
Brown	Live	L
Blue	Neutral	N
Yellow /Green	Earth	E

**6. Replacing fuse :**

Disconnect from the main power supply first, then remove the fuse from the IEC Socket or fuse holder . Replace with a fuse of the correct rating as stated on product label or user guide.

**7. Caution:**

For your safety, please kindly pay attention to all of the warnings below:

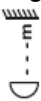
- Always plug in the power plug last and disconnect from the mains when the device is not in use or before cleaning.
- Do not install and operate the device in rain or extreme heat, moisture or dusty environments.
- This device is for indoor use only and in a dry environment.
- Do not switch on immediately. Wait until the unit reaches room temperature.
- Do not shake the device and avoid brute force when installing or operating
- Do not use the device during thunderstorms and please disconnect the power.
- Do not use solvents or aggressive detergent to clean the device. Use a soft and clean cloth.
- Do not modify the device or the connected power cord without authorization.
- Do not stare into the aperture. This product emits hazardous levels of optical radiation and will cause serious injury to the eyes if viewed at close range.
- This product should be securely mounted so that its output emission is always directed away from people and at objects that are able to reflect emission towards people. In this regard, the separation distances cited in HS(G)95 should be observed.
- The symbol  determines the minimum distance from lighted objects. The minimum distance between light-output and the illuminated surface must be more than 0.5m.



qtxlight

**8. General maintenance:**

Be sure to power off the fixture before conducting maintenance.

To maintain optimum performance and minimize wear, fixtures should be cleaned frequently. Usage and environment are contributing factors in determining frequency. As a general rule, fixtures should be cleaned at least twice a month. Dust build-up reduces can reduce light output & performance as well as overheating. This can lead to reduced life and increased mechanical wear.

Unplug fixture from power. Use a vacuum or air compressor and a soft brush to remove dust collected on external vents and internal components. Clean all glass when fixture is cold with a mild solution to the cloth or tissue, and drag dirt and grime to the outside of the lens. Gently polish optical surfaces until they are free of haze and lint.

The cleaning of internal and external optical lenses and/or mirrors must be carried out periodically to optimize light output. Cleaning frequently depends on the environment in which the fixture operates: damp, smoky or particularly dirty surroundings can require cleaning fluid. Always dry the parts carefully. Clean the external optics at least every 20 days.

**9. Quick trouble shooting :**

7.1 If the unit does not function – Check that the main power is on and the fuse is intact.

7.2 If the unit is not reacting to music – check the unit is in “sound to light” mode and that the sensitivity control is fully clockwise.

7.3 If the product is not reacting to DMX signals, check the cables and connections



qtxlight