

# KAM

## INSTRUCTION MANUAL

# iLINK GREEN

Linkable green DMX laser with remote control

M A N U A L   V E R S I O N   1 . 0  
2 8 - 0 6 - 1 2

Green DMX laser with remote control  
Part of the Kam iLink laser series  
Stepping motor  
Full remote control  
Full DMX512 operation  
8 DMX channels  
Auto mode / Sound-to-Light via built-in mic  
Master/Slave modes  
LED display  
Tough metal chassis / Adjustable metal hanging bracket / Safety chain loop  
Safety key On/Off lock  
Mains fused IEC

For the latest instruction manual updates and information on the entire Kam range visit:

[www.kam.co.uk](http://www.kam.co.uk)

Kam products are manufactured by: **Lamba plc**, Unit 1, Southfields Road, Dunstable, Bedfordshire, United Kingdom LU6 3EJ  
Telephone: (+44) (0)1582 690600 • Fax: (+44) (0)1582 690400 • Email: [mail@lambapl.com](mailto:mail@lambapl.com) • Web: [www.lambapl.com](http://www.lambapl.com)

If this product is ever no longer functional please take it to a recycling plant for environmentally friendly disposal.

Due to continuous product development, specifications and appearance are subject to change.

© Copyright Lamba plc 2012. E&OE.

**Thank you for purchasing this KAM product, we are sure that it will serve you for many years to come.**

To optimise the performance of this product, please read these operating instructions carefully to familiarise yourself with the basic operations of this unit. After you have read the instructions, please retain them for future reference.

This unit has been tested at the factory before being shipped to you.

To prevent or reduce the risk of electrical shock or fire, do not expose the unit to rain or moisture. To prevent a fire hazard, do not expose the unit to any naked flame sources. Unplug this apparatus during lightning storms or if it is unlikely to be used for long periods of time.

When installing the unit, please ensure you leave enough space around the unit for ventilation. Slots and openings in the unit are provided for ventilation to ensure reliable operation of the product and to protect it from overheating. To prevent fire hazard, the openings should never be blocked or covered.

Always handle the power cable by the plug. Never pull out the plug by pulling on the cable. Never touch the power cable when your hands are wet as this could cause an electric shock. Do not tie a knot in the cable. The power cable should be placed such that it is not likely to be stepped on. A damaged power cable can cause a fire or give you an electrical shock. Check

the power cord periodically, if you ever find that it is damaged, replace it before using the unit again. Contact your retailer for a replacement.

The voltage of the available power supply differs according to country or region. Be sure that the power supply voltage of the area where this unit is to be used meets the required written on the unit.



**The lightning flash symbol inside a triangle is intended to alert the user to the presence high voltage within the unit's enclosure that may be of sufficient power to constitute a risk of electrical shock to persons.**

**Caution: to prevent the risk of electric shock, do not attempt to open the unit. No user-serviceable parts inside. Refer all servicing to qualified service personnel.**

**The exclamation mark inside a triangle is intended to alert the user to the presence of important operating and maintenance instructions in the literature accompanying the appliance.**

Any modification carried out on the unit may invalidate the unit's warranty.

If applicable, only use the stand, tripod or bracket specified or sold with the apparatus.

Select the installation location of your unit carefully. Avoid placing it in direct sunlight or locations subject to vibration and excessive dust. Do not use the unit where there are extremes in temperature (below 41°F / 5°C or exceeding 95°F / 35°C).

Unpacking and safety: Please unpack your new product carefully, your new product should reach you in perfect condition. Please check that no damage has occurred during transit. If any damage is found, do not operate your unit. Please contact the retailer you purchased it from immediately. If there is any damage to the mains cable do not use the device. Always disconnect the unit from the mains supply when carrying out any servicing or cleaning of the unit.

The serial number for this equipment should be located on the rear or underside of the unit. Please make a note of this number as you will need it for your warranty, it is a good idea to keep a copy of the serial number for your own records.

## Panel

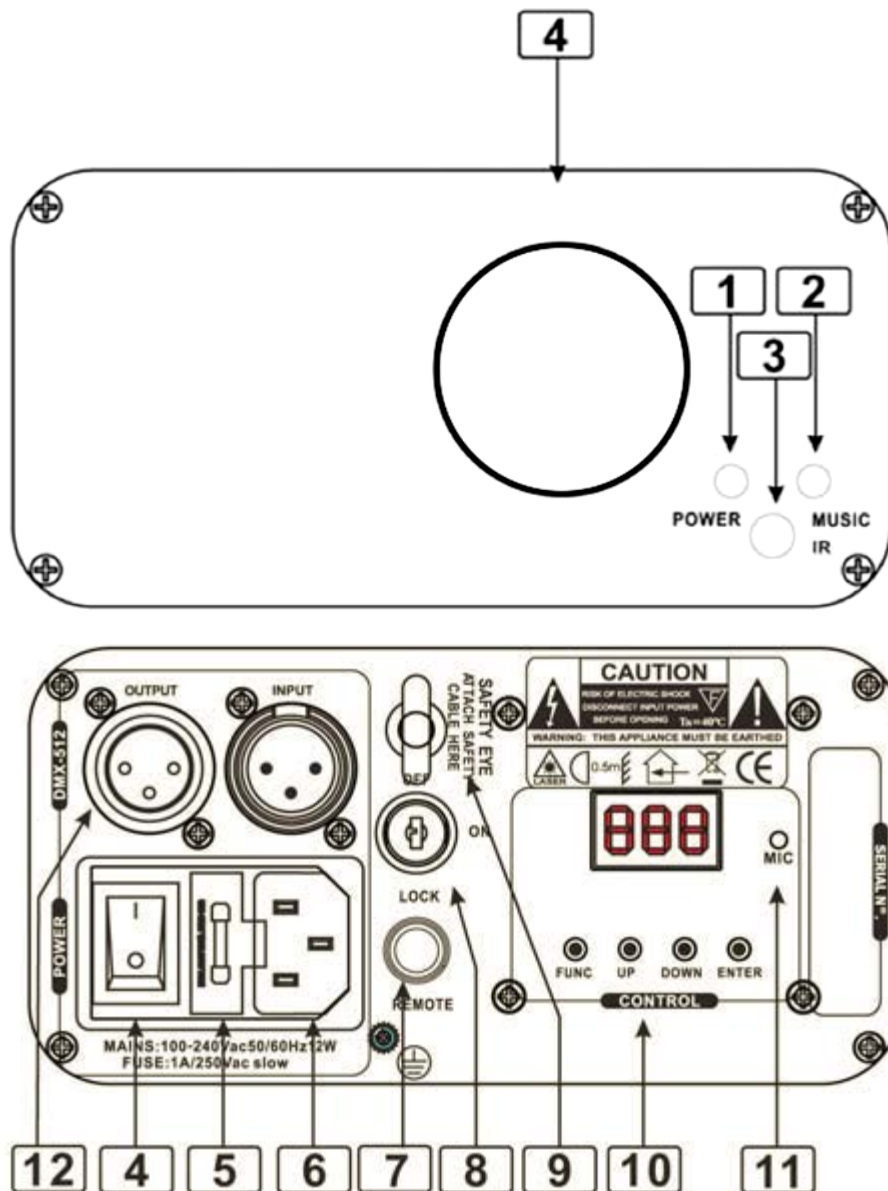

NO.	NAME	DESCRIPTION
1	Power LED	Indicates the laser is switched on
2	Music LED	Sound-to-Light signal
3	IR Receiver	Remote controller signal receiver
4	Laser Aperture	The laser effect output aperture. NEVER LOOK INSIDE THE FIXTURE THROUGH THIS APERTURE WHILE FIXTURE IS OPERATING.
4	Power Switch	Switch ON and OFF the fixture
5	Fuse Holder	Replace fuse with correct value if required
6	Main Power Input	IEC socket and integrated fuse holder.
7	Interlock	For laser emergency stop
8	Key switch	Safety key switch operates laser output
9	Safety eye	Attach the safety cable/chain
10	Control panel	LED menu function display
11	Microphone	To detect the music/sound signal
12	DMX Input/Output	3 pins male/female XLR connector

### Control & Function

Regular breaks during operation are essential to maximize the life of this device as it is not designed for continual use. Always unplug the unit when it is not being used for long periods or before servicing. In the event of serious operation problems, stop using the unit and contact your dealer immediately.

**Note:** There will output from laser 5 seconds after the unit is powered on.

### Operation

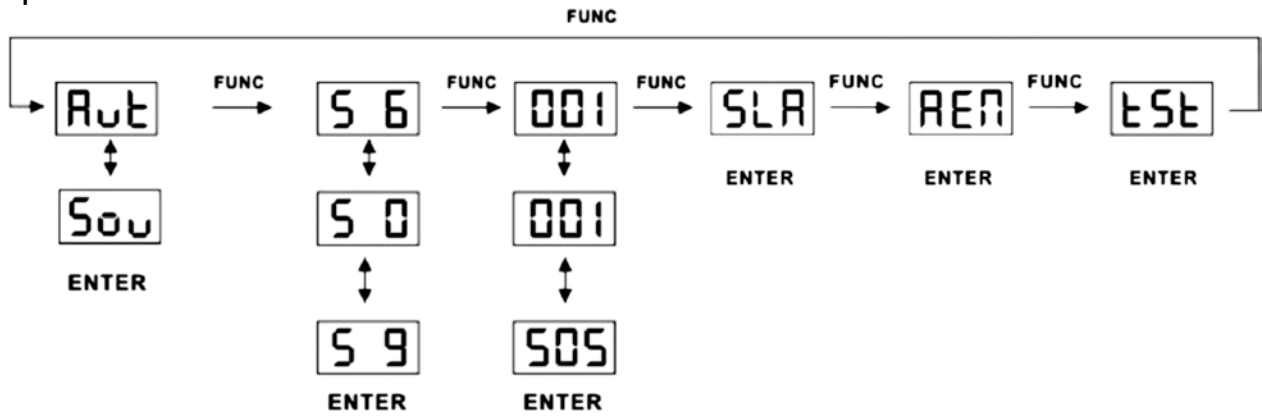

### Standalone pre-program laser show

Press FUNC to enter MODE OPTION.

Till the LED panel shows AUt.

Press ENTER to confirm the setting.

### Auto mode

The laser will return to Auto mode once the power is turned off/on.

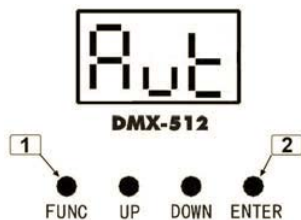

### Sound activated show (Music Show) Standalone mode

Press FUNC to enter MODE OPTION.

Till the LED panel shows SoU.

Press ENTER to confirm and save the setting.

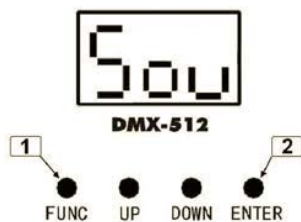

### Sound activated mode sensitivity setting

Press FUNC till to see S\*\*.

Press UP/DOWN to set microphone sensitivity. S 0 is no sound activation, from S1 to S9 is sound activated, S1 min S9 max.

Press ENTER to confirm and save the setting.

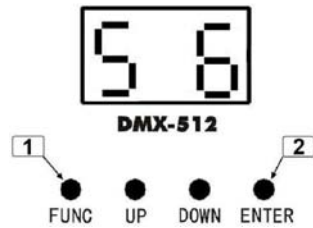

The sound sensitivity can be adjusted to determine how sensitive the laser is to sound. In the S\*\* mode there are 10 different options.

Zero = sound off

1-9 = from low to high sensitivity

A suggested setting would be in the range of 5-7. If this range is too sensitive reduce the value, if more sensitivity is required increase the value. Remember to press enter to confirm your selection.

This setting will remain in the memory when powered off (and permanently stored in the flash memory).

### DMX mode

Press FUNC to enter MODE OPTION.

Till to LED panel shows 001.

Use the up / down buttons to select the desired DMX starting address

Press ENTER to confirm the setting.

The laser is working in "DMX MODE". With the help of UP/DOWN button, choose your DMX starting address.

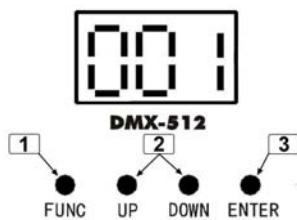

### Master/slave mode

Linking several units without a DMX controller

#### Master unit

Press FUNC and select desired auto option sound or auto

Press the enter button to confirm

#### Slave unit

Press the mode button until LED panel shows SLA

Press ENTER to confirm the setting.

All units set to SLA will follow the master unit

These must be linked together using a 3pin XLR DMX cable (not supplied)

**Note:** only one unit must be set to master all other units set to slave.

When linking this unit to other iLink lasers always use the iLink Green as the master unit and the other units as slave units, this will allow the remote to control all the lasers.

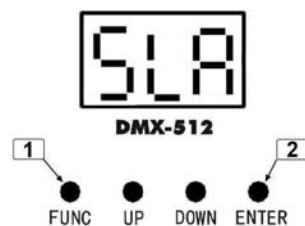

**Remote mode**

Press FUNC to enter MODE OPTION.  
 Until the LED panel shows REN  
 Press ENTER to confirm the setting.

**Remote instructions**

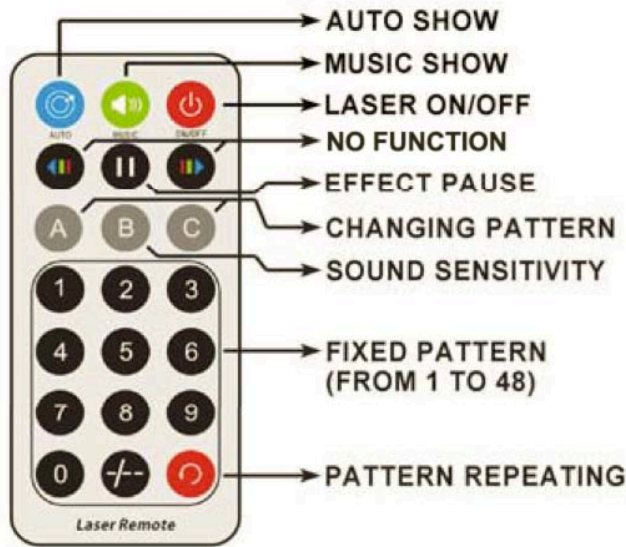

Button	Function	Description
	ON/OFF	In REM mode, to turn ON/OFF laser. In any stand alone mode, except for SLA mode, pressing this button for 2 seconds will activate the REM mode.
	Auto	Auto running slow
	Music	Sound Activated show. The blue music LED indicator is flashing when sound signal is detected.
	Sound sensitivity	In Sound Activated Mode, press Music + B + "1-9" to adjust the sensitivity setting. "9" is the most sensitive.
	N/A	No function
	Pattern changing	To show and change patterns
	Fixed pattern	Choose favourite pattern from 1 to 48
	Pattern repeat	Last pattern and current pattern cycle repeating

**Controlling units via DMX** - each unit uses 8 DMX channels

To set the DMX address

1. Press the function button until \*\*\* is displayed (range 001-512)
2. Using the up / down buttons select the desired DMX starting address
3. Press the enter button to confirm
4. Continue this formula to address any additional units

Note on setting the DMX address of units - if one or several units are to be controlled at the same time with the same features set, all units DMX address needs to be the same

Example all units to 001

If individual control of several units is required

Each unit must have its on unique address and no channels must cross

Example unit 1 set to 001 – unit 2 to 09 etc adding 8 clear channels each time

**Master slaving units with no DMX controller**

Set the master unit to the desired setting

Example auto or sound







Set all other units to slave mode

To set slave mode press the function button until SLA is displayed then press the enter button to confirm











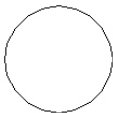







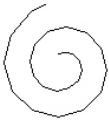





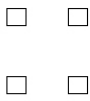
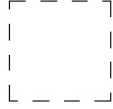





Only one unit must be set as a master and all other units as a slave

Connect each unit together via a 3pin DMX lead

**DMX Protocol**

CHANNEL	VALUE	FUNCTION	
CH1 MODE	000-063	Laser black out	
	064-127	Auto show	
	128-191	Sound activated show (music)	
	192-255	DMX MODE (other channels activated)	
CH2 PATTERN	000-255	32 Patterns as shown in PATTERN LIST	
CH3 ZOOMING	000-127	100%-5% Size 	
	128-169	Zooming in	
	170-209	Zooming out	
	210-255	Zooming in and out	
CH4 Y AXIS ROLLING	000-127	0 -359 degree fixed Y axis rolled	
	128-191	Clockwise rolling	
	192-255	Anticlockwise rolling	
CH5 X AXIS ROLLING	000-127	0 -359 degree fixed X axis rolled	
	128-191	Clockwise rolling	
	192-255	Anticlockwise rolling	
CH6 Z AXIS ROLLING	000-127	0 -359 degree fixed Z axis rotate	
	128-191	Clockwise rotating	
	128-255	Anticlockwise rotating	
CH7 X AXIS MOVING	000-127	128 different fixed position on X	
	128-191	Clockwise moving	
	128-255	Anticlockwise moving	
CH8 Y AXIS MOVING	000-127	128 different fixed position on Y	
	128-191	Clockwise moving	
	128-255	Anticlockwise moving	

### Pattern list in channel 2

DMX	PATTERNS	DMX	PATTERNS	DMX	PATTERNS	DMX	PATTERNS
000-007		064-071		128-135		192-199	
008-015		072-079		136-143		200-207	
016-023		080-087		144-151		208-215	
024-031		088-095		152-159		216-223	
032-039		096-103		160-167		224-231	
040-047		104-111		168-175		232-239	
048-055		112-119		176-183		240-247	
056-063		120-127		184-191		248-255	

### Specifications

Mains Input	AC100-240V, 50/60Hz
Fuse	250V 1 A slow blow (20mm Glass)
Total Power	12W
Music Control	Internal microphone
Laser Power	40mW 532nm green laser
Laser Classification	Class 3B
Laser Safety Standard	EN60825-1 2007
Condition Temperature	10~40°C
DMX Connections	3 pins XLR Male/Female
DMX Channels	8 channels
Measurement	145 x 160 x 80mm
N Weight	1.3 Kg